



Air Source Heat Pump Water Heater

Installation and User Instructions



GDC Group Ltd is a licensed member of the Benchmark Scheme which aims to improve the standards of installation and commissioning of domestic heating and hot water systems in the UK and to encourage regular servicing to optimise safety, efficiency and performance.

Benchmark places responsibilities on both manufacturers and installers. The purpose is to ensure that customers are provided with the correct equipment for their needs, that it is installed, commissioned and serviced in accordance with the manufacturer's instructions by competent persons and that it meets the requirements of the appropriate Building Regulations. The Benchmark Checklist can be used to demonstrate compliance with Building Regulations and should be provided to the customer for future reference.

Installers are required to carry out installation, commissioning and servicing work in accordance with the Benchmark Code of Practice which is available from the Heating and Hot Water Industry Council who manage and promote the Scheme. Visit www.benchmark.org.uk for more information.

The Hot Water Association (HWA) Charter is a code of Practice which requires that all members adhere to the following:

- *supply fit for purpose products clearly and honestly described*
- *supply products that meet, or exceed appropriate standards and building and water regulations*
- *provide pre and post sales technical support*
- *provide clear and concise warranty details to customers*

For further information on HWA Charter Membership, please refer to HWA website www.hotwater.org.uk'

All cylinders are certified by KIWA, for further information on this regulation body please refer to the KIWA website www.kiwa.co.uk'

These products are tested in accordance with EN12897:2016

Contents

1	Manual Warnings	4	7	Set-Up and Use	12
2	Safety Information	4	7.1	Commissioning	12
3	Introduction	5	7.2	Using your Hot Water Heat Pump	13
4	Scope of Delivery	5	7.3	Control Box	13
5	Pre-Installation	5	7.4	Setting the Language	13
5.1	Handling	5	7.5	Setting the Time	13
5.2	Unpacking	5	7.6	Setting the Water Temperature	14
5.3	Pipework	6	7.7	Standby Mode	14
5.4	Taps and Fittings	6	7.8	Boost Function	14
5.5	Risk Assessment	6	7.9	Electric Mode	14
5.6	Siting Considerations	6	7.10	Programming	15
5.7	Cold Water Supply	6	7.11	Installer Menu	16
5.8	Building Regulation G3 Discharge Requirements	7	7.11.1	PV Mode	16
5.8.1	Discharge Pipe D2	7	7.11.2	Adjusting the Operating Settings	16
5.8.2	Worked Example	7	7.11.2.1	Anti-Bacteria	17
5.8.3	Termination of Discharge Pipe	8	7.11.2.2	Fan Mode	17
5.9	Product Disposal	8	7.11.2.3	Minimum Temperature	17
			7.11.2.4	Shedding	17
			7.11.2.5	Maximum Heating Time	18
			7.11.3	Locking the Keypad	18
			7.11.4	Resetting Parameters	18
			7.11.5	Reading Display	19
			7.11.6	Counters (Meters)	19
6	Installation	8	8	Maintenance	19
6.1	Correctly Site the Cylinder	8	8.1	DHW Cylinder	19
6.2	Cold Water Inlet with Inlet Control Group	8	8.2	Heat Pump	19
6.2.1	Install the Inlet Group	8	8.3	Air intake & Exhaust	20
6.2.2	Expansion Vessel	8	8.4	Heat Pump Condensation	20
6.2.3	Balanced Cold Water Supply	9	8.5	Electrical Connections	20
6.2.4	Drain Valve	9	8.6	Troubleshooting	21
6.3	Hot Water Outlet	9	8.7	Spare Parts	22
6.3.1	Thermostatic Mixing Valve	9	8.8	Error Codes	23
6.3.2	Pipe Insulation	9			
6.4	Discharge Pipes from Safety Devices	9	9	Warranty	25
6.4.1	Discharge Pipe D1	9	9.1	Warranty Limits	25
6.4.2	Discharge Pipe D2	9	9.1.1	General Information	25
6.4.3	Tundish	9	9.1.2	Exclusion from Warranty	25
6.5	Immersion Heaters	9	9.1.2.1	Use	25
6.6	Air Connection	10	9.1.2.2	Handling	25
6.7	Ducting Design	10	9.1.2.3	Installation Site	25
6.7.1	Worked Example	10	9.1.2.4	Electrical Connections	25
6.8	Condensates Draining	10	9.1.2.5	Hydraulic Connections	26
6.9	Electrical Connections	11	9.1.2.6	Accessories	26
6.9.1	Accessing Electrical Connections	11	9.1.2.7	Maintenance	26
6.9.1.1	Electricity Provider Contact	11			
6.9.1.2	Connecting the PV Function	11	10	Technical Data	27

1 Manual Warnings



Electrical Warnings

Indicates any hazard of an electrical nature.

Information



Indicates tips and advice for the smooth operation of the system.

General Warnings



Indicates a general warning against actions which could result in damage to the system or personal injury to the installer and/or user.

2 Safety Information



This appliance can be used by children aged 8 years and above and persons with reduced physical, sensory or mental capabilities or lack of experience and knowledge if they have been given supervision or instruction concerning use of appliance in a safe way and understanding the hazards involved - some parts of this product can become hot and cause burns. Children shall not play with the appliance. Cleaning and user maintenance shall not be made by children without supervision.



No isolating device may be fitted between the inlet group and the cold water inlet on the cylinder, as by doing so important safety devices could be isolated!



The maintenance of this appliance must be carried out by suitable qualified person only. It is recommended to maintain the unit on an annual basis. Isolate all electrical supplies from the unit before commencing work. Danger of electrical shock!



It is important that the tundish is positioned away from any electrical components.



Means for electrical disconnection must be incorporated in the fixed wiring in accordance with the wiring rules.



Before removing the cover from the immersion heater isolate the appliance using isolating switch! Danger of electrical shock! Only use suitable electrically insulated equipment when working inside immersion housing.



The cylinder must be filled with water before switching on the immersion heater. Failure to do so will damage the element and void the warranty.



The appliance should be installed in a place where it is not exposed to damp and is not at risk of being splashed with water.



It is important to check the pre-charge pressure of the expansion vessel membrane before filling the cylinder. This has been factory set to 3 bar. The pre-charge should be greater than or equal to 3 bar.



A high level cut-out is fitted to the product for each heat source. This should never activate under normal operation.

Please retain manual for future reference.

If an electronic copy of this manual should be required, please contact the manufacturer at the address at the back of this manual.

3 Introduction

Thank you for choosing this product. The Edel Air Source Heat Pump water heaters are specified with high quality, immersion heaters for fast reheat times. They boast 50mm of low GWP insulation foam, together with 100% recyclable stainless steel inner components and a hard wearing outer shell manufactured from completely recycled materials.

Note:

This product has been designed specifically for the purpose of delivering heated, domestic and sanitary hot water as part of a pressurised water heating system. The package is provided with fittings that comply with Section G3 of Building Regulations.



Dimplex cannot take responsibility for ensuring safe operation of the appliance outside of the scope of intended use.

4 Scope of Delivery

Scope of delivery		
Cylinder volume		200l 270l
Cylinder with 1.5kW immersion *		1 1
T+P valve *		1/2", 7bar/90°C
Inlet control group consisting of:-		✓
- in line strainer		
- 3 bar PRV		
- 6 bar ERV		
- non-return valve		
- balanced cold water supply port		
- connection for expansion vessel		
Expansion vessel with fixing kit and connection hose		19l[Pre-charge pressure 0.3MPa (3 bar)]
Tundish		15mm/22mm

Table 1: Scope of Delivery for Edel Water Heater

* These items are supplied factory fitted

5 Pre-Installation Advice

Please read the following section carefully before commencing installation. If in any doubt, please call the appropriate help desk. Disregarding the instructions given in this manual in its entirety and any relevant regulations, standards and codes of practice will void the guarantee of this product.

5.1 Handling

The upper covers of the appliance are not made to withstand force and should not be used for handling purposes.

Non-permitted transport positions:

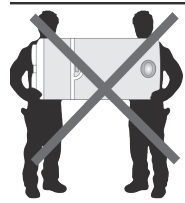

Transporting the appliance in a horizontal position may lead to irreparable damage to the components of the heat pump

Permitted transport positions:

No other transport position is authorised



All other transport positions are PROHIBITED

If tipped, the centre of gravity will shift towards the top: handle with care.

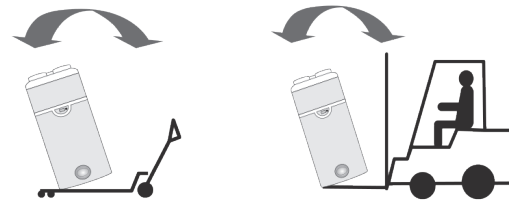

Risk of tipping/falling

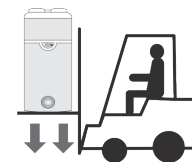

Do not drop or lower suddenly

Please note that handling, installation and use of this product is subject to the Health and Safety at Work Act. If the unit is not installed immediately, it should remain in its protective packaging with all pipe protectors/end caps applied to prevent damage and dirt deposit inside the water heater and the coil.

5.2 Unpacking

- Remove plastic cover and cardboard packaging.
- Remove corner protection pieces, ensuring that all nails and staples are taken out.
- Remove protective film from all parts of the appliance and from the bag of accessories which you will find in the transport bag.
- Without tilting the appliance, use an appropriate tool to remove the screws from underneath the pallet.

Keep the transport bag out of reach of children (risk of suffocation).

5.3 Pipework

The pipe runs should be executed as short as possible, unused pipework should be removed and all remaining pipework should be lagged in accordance with regulatory requirements to prevent heat loss and the formation of condensation.

5.4 Taps and Fittings

All taps and fittings incorporated in the system should have a rated operating pressure of 0.6 MPa (6 bar) or above.

5.5 Risk Assessment

It is strongly recommended to complete a risk assessment before installing the product. The following areas require particular consideration in addition to the information required by the Health and Safety at Work Act.

- Scalding: where appropriate or required by law a thermostatic mixing valve is to be fitted to the hot water outlet of the cylinder.
- Explosion: the unit is fully equipped with all relevant safety equipment to comply with current regulations. The correct design and function has been verified by independent third party testing. The correct application hereafter is the responsibility of the competent installer.
- Water borne organisms (i.e. Legionella): if applicable a risk assessment should be carried out following the recommendations outlined in the Approved Code of Practice L8.
- The user preference must be considered when commissioning the system.

5.6 Siting Considerations

When choosing the place where the appliance is to be installed the following points should be taken into consideration:

- Structural integrity.
- Access for installation, operation, maintenance and replacement.
- Routing of discharge pipework.
- Access to water mains supply, hot and cold water distribution pipework.
- Access to suitable electricity supply.

It is PROHIBITED:

- To let the appliance operate using air intake which contains solvents or explosive matter.
- To use air intake which contains grease, dust or aerosol particles.
- To connect vented exhaust hoods to the ventilation system.

It is PROHIBITED to install the appliance

- Outdoors
- In rooms which are exposed to frost
- In humid rooms which have a lot of steam or vapour (for example, a bathroom)

The water heater may be located on any flat and level surface, provided it is sufficiently robust to support the weight of the water heater when full of water (please see technical data) and suitably accessible for replacement/maintenance without specialist tools or lifting equipment as this will void the warranty conditions.

Particular care must be taken when placing the water heater in a garage or outbuilding. All exposed pipework must be correctly insulated to avoid frost damage.

The position and orientation of the water heater should be such that easy access is provided for servicing the controls. A minimum distance of 400mm in front of the immersion is recommended, to allow the replacement of the immersion heater should the need arise. When installing the water heater all labels should be clearly visible and ensure that no pipework hinders any work to be carried out on the various components.

To facilitate the condensates flow, adjust the feet so that the appliance is horizontal, see Figure 1.

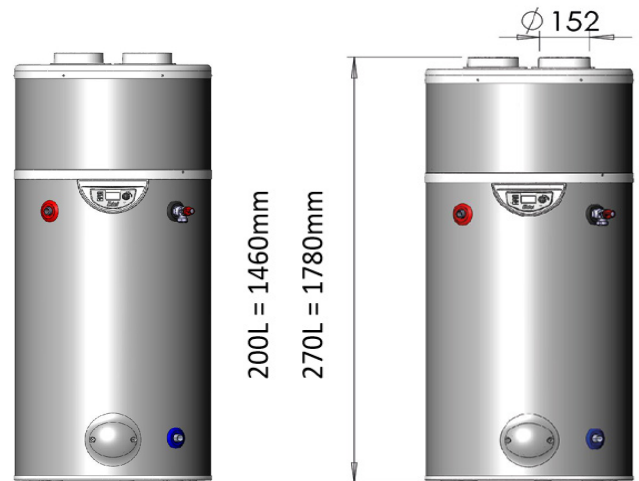

Figure 1: Correct siting of Water Heater

5.7 Cold Water Supply

For satisfactory and safe performance of the water heater the water supply must meet the following criteria:

Minimum dynamic pressure	150Kpa (1.5 bar)
Maximum inlet supply pressure	1200Kpa (12 bar)
Minimum flow rate	15l/min
Max. chlorine content	250mg/L
Max. water hardness	200mg/L

The following instructions have to be followed when installing the cold water mains supply to the water heater:

- The cold water supply to the water heater must come directly from the cold water mains after the mains stop valve to the property.
- The cold water inlet pipework should have at least an inside diameter of 19mm and should meet the requirements of the water regulations for the supply of wholesome water.

Dimplex recommend an annual maintenance inspection is carried out on the water heater. In hard water areas this should include inspection of the immersion heater, [above 120ppm or 120mg/l]. A local water treatment company should be able to offer free water quality testing. The heating elements may require periodic de-scaling. The installer should do this as part of a maintenance agreement.

If required, precautions can be taken to minimise effects of water hardness, i.e. installation of water conditioner or water softener. These devices should be installed in hard water areas where high water storage temperatures are required, i.e. greater than 60°C storage temperatures, particularly when water hardness exceeds 200ppm. Should the water heater require de-scaling, this must be performed by a qualified technician.

5.8 Building Regulation G3 Discharge Requirements

As part of the requirements of Building Regulation G3 this product is factory fitted with a T&P valve, which complies with BS EN 1490. Any discharge from a water heater system should be conveyed to where it is visible, but will not cause danger to persons in or about the building. The tundish and the discharge pipes should be fitted in accordance with the requirements of Building Regulation approved document G3, (England and Wales), Part P of Northern Ireland and Standard 4.9 of Scotland.

5.8.1 Discharge Pipe D2

The discharge pipe (D2) from the Tundish should:

- "have a vertical section of pipe at least 300mm long below the tundish before any elbows or bends in the pipework and be installed with a continuous fall of at least 1 in 200 thereafter."

The discharge pipe (D2) should be made of:

- "metal; or other material that has been demonstrated to be capable of safely withstanding temperatures of the water discharged and is clearly and permanently marked to identify the product and performance standard"

Dimplex strongly recommends the use of metal pipework only and Dimplex does not take responsibility for any damage caused from discharges.

The discharge pipe D2 should be at least one pipe size larger than the nominal outlet size of the safety device unless its total equivalent hydraulic resistance exceeds that of a straight pipe 9m long, i.e. for discharge pipes between 9m and 18m the equivalent resistance length should be at least two sizes larger than the nominal outlet size of the safety device; between 18m and 27m at least 3 sizes larger, and so on; bends must be taken into account in calculating the flow resistance. See Figure 2, Table 2 and the worked example.

Note: An alternative approach for sizing discharge pipes would be to follow Annex D, section D.2 of BS 6700:2006 + A1:2009).

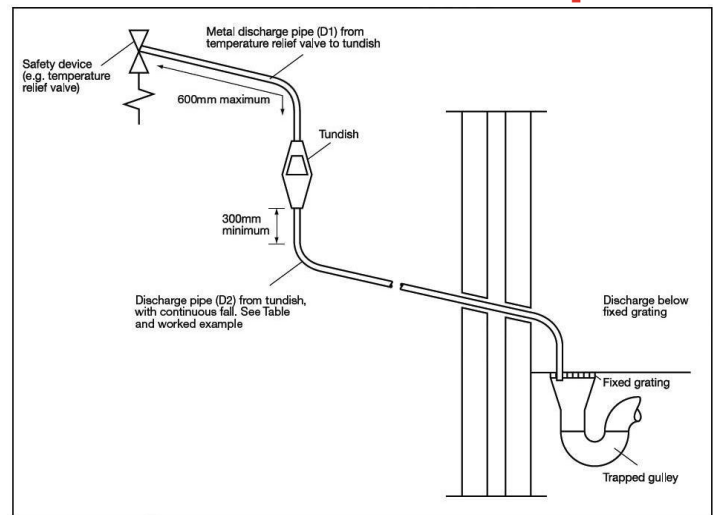

Figure 2: Typical discharge pipe arrangement

Value outlet size	Minimum size of discharge pipe before tundish (mm)	Minimum size of discharge pipe after tundish (mm)	Maximum allowed length of pipe after tundish (m)	Length to be subtracted for each elbow or bend (m)
G1/2	15	22	9	0.8
		28	18	1.0
		35	27	1.4
G3/4	22	28	9	1.0
		35	18	1.4
		42	27	1.7
G1	28	35	9	1.4
		42	18	1.7
		54	27	2.3

5.8.2 Worked Example

This example is for a G $\frac{1}{2}$ temperature relief valve with a discharge pipe (D2) having 4 No. 22mm elbows and length of 7m from the tundish to the point of discharge.

From Table 2, the maximum resistance allowed for a straight length of 22mm copper discharge pipe (D2) from a G $\frac{1}{2}$ temperature relief valve is 9.0m. Subtract the resistance for 4 No. 22mm elbows at 0.8m each = 3.2m.

Therefore the maximum permitted length equates to 5.8m, which is less than the actual length of 7m, therefore calculate the next largest size.

Maximum resistance allowed for a straight length of 28mm copper discharge pipe (D2) from a G $\frac{1}{2}$ temperature relief valve is: 18m.

Subtract the resistance for 4 No. 28mm elbows at 1.0m each = 4m.

Therefore the maximum permitted length equates to 14m.

As the actual length is 7m, a 28mm (D2) copper pipe will be satisfactory.

- Where a single common discharge pipe serves more than one system, it should be at least one pipe size larger than the largest individual discharge pipe (D2) to be connected.

- The discharge pipe should not be connected to a soil discharge stack unless the soil discharge stack is capable of safely withstanding temperatures of the water discharged, in which case, it should:
- Contain a mechanical seal, which allows water into the branch pipe without allowing foul air from the drain to be ventilated through the tundish.
- There should be a separate branch pipe with no sanitary appliances connected to it.
- If plastic pipes are used as branch pipes carrying discharge from a safety device, they should be either polybutalene (PB) or cross-linked polyethylene (PE-X) complying with national standards.
- Be continuously marked with a warning that no sanitary appliances should be connected to the pipe.

5.8.3 Termination of discharge pipe

- "The discharge pipe (D2) from the tundish should terminate in a safe place where there is no risk to persons in the vicinity of the discharge."

Examples of acceptable discharge arrangements are:

- "To a trapped gully with the end of the pipe below a fixed grating and above the water seal;
- Downward discharges at low level; i.e. up to 100mm above external surfaces such as car parks, hard standings, grassed areas etc. are acceptable providing that a wire cage or similar guard is positioned to prevent contact, whilst maintaining visibility; and ,
- Discharges at high level: e.g. into a metal hopper and metal downpipe with the end of the discharge pipe clearly visible or onto a roof capable of withstanding high temperature discharges of water and 3m from any plastic guttering system that would collect such discharges."



As the discharge would consist of high temperature water and steam, asphalt, roofing felt and non-metallic rainwater goods may be damaged by such discharges.

5.9 Product Disposal



This product has been manufactured from mostly recyclable materials. At the end of the product's life, it should be disposed of at a Local Authority Recycling Centre.

Materials:

- Inner Cylinder - Stainless Steel
- Outer Cladding - HIPS/ABS (Polypropylene BE 50)
- Inlet/Outlet Pipe - Plastic (Polypropylene BE 50)
- Insulation - 50mm PU Foam (GWP =1, ODP =0)

Connections & Fasteners:

- Inlet/Outlet - stainless steel
- T&P Valve - 1/2" F BSP
- Immersion Heater - 1 1/4" F BSP

Safety & Control:

- Cold water inlet group - brass
- Tundish - acetal co-polymer
- T&P Valve - brass
- Expansion vessel with flexible hosing - mild steel

6 Installation

6.1 Correctly Siting the Water Heater

Install the water heater in an appropriate location, ensuring all of the recommendations have been considered (see Section 5.6).

6.2 Cold Water Inlet with Inlet Group

6.2.1 Install the Inlet Group

The inlet group regulates the pressure of the incoming mains water supply to the water heater and removes any debris that might be water borne.



Between the inlet group and the cold water inlet on the water heater NO isolating device may be fitted, as by doing so important safety devices could be isolated!

6.2.2 Expansion Vessel

The expansion vessel is mandatory on the Dimplex water heater and can be connected directly to the cold water inlet group, utilising the flexible hose supplied with the vessel. The expansion vessel should always be fitted in accordance with the manufacturer's instructions, see Figure 3. No isolating device should be fitted between the water heater and the cold water inlet group.

Furthermore, it is recommended to mount the vessel higher than the water heater to avoid having to drain the water heater when maintaining and replacing the expansion vessel.

It is important to check the pre-charge pressure of the expansion vessel membrane before filling the cylinder. The pre-charge should be greater than or equal to 3 bar.



Figure 3: Connection of the expansion vessel to the inlet group

Note: The expansion vessel must be installed to the side of the expansion relief valve on the inlet group. To do this the blanking plug must be removed and the expansion vessel connected, as shown in Figure 4.

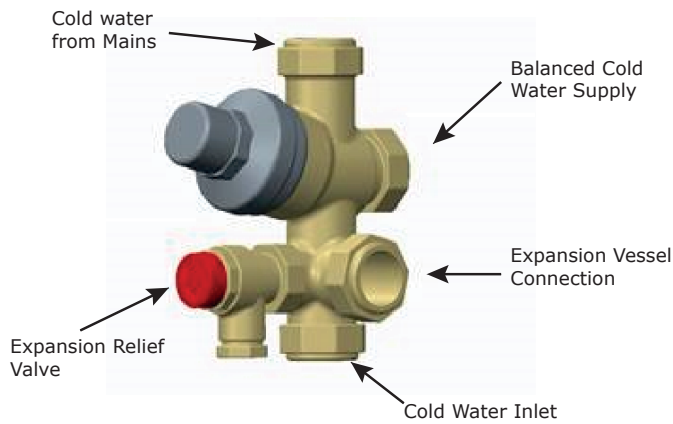

Figure 4: Detail showing the connection of the expansion vessel to the inlet group

6.2.3 Balanced Cold Water Supply

If balanced cold water supply is required a connection can be taken from the bottom of the inlet group.

6.2.4 Drain Valve

It is also recommended to install a drain valve (not supplied) in the lowest point of the cold water feed to the water heater. This allows the water heater to be drained in a controlled manner should this become necessary.

6.3 Hot Water Outlet

The hot water pipework is to be directly connected to the hot water outlet connection on the water heater.

6.3.1 Thermostatic Mixing Valve

A thermostatic mixing valve may be required to limit the outlet temperature. In this case, the valve should be installed following the manufacturer's instructions, ensuring none of the safety equipment has been isolated, (i.e. make sure the connection to the thermostatic mixing valve is taken after the safety equipment of the inlet group).

6.3.2 Pipe Insulation

It is recommended to insulate the hot water pipework from the water heater to the outlets, to reduce the energy requirements for providing hot water. It is also recommended to insulate all other exposed pipework, such as the T&P to the tundish, the coil flow and return and the cold water inlet pipes.

6.4 Discharge Pipes from Safety Devices

6.4.1 Discharge Pipe D1

The temperature and pressure relief valve must be discharged directly or by way of a manifold via a short length of metal pipe (D1) into a tundish; and the discharge pipe must be installed in a continuously downward direction and in a frost free environment. Water may drip from the discharge pipe of the pressure relief device and this pipe must be left open to the atmosphere.

The diameter of discharge pipe (D1) should not be less than the nominal outlet size of the safety device, e.g. temperature relief valve.

Where a manifold is used it should be sized to accept and discharge the total discharge from all the D1 discharge pipes connected to it.

The discharge pipework from the expansion relief valve must be installed constantly falling to an open point of discharge. It is recommended to combine it with the discharge of the temperature and pressure relief valve.

Note: The T&P valve is pre-sealed and if moved the seal will be broken, should this occur, it will need to be resealed with an appropriate sealant (Dimplex part number R00836-1).

6.4.2 Discharge Pipe D2

For a detailed description of the discharge pipework D2 (see Section 5.8.1).

6.4.3 Tundish

The tundish should be vertical, located in the same space as the unvented hot water storage system and be fitted as close as possible to, and lower than, the safety device, with no more than 600mm of pipe between the valve outlet and the tundish (see Figure 2).

Where discharge may not be apparent, e.g. in dwellings occupied by people with impaired vision or mobility, consideration should be given to the installation of a suitable safety device to warn when discharge takes place, e.g. electronically operated.

Note: To comply with the Water Supply (Water Fittings) Regulations, the tundish should incorporate a suitable air gap.

Note: It is important that the tundish is positioned away from any electrical components.

6.5 Immersion Heater

The Edel Air Source Heat Pump Water Heater comes with the immersion heater factory fitted and wired. The immersion heater incorporates an independent non-self resetting over temperature cut-out. Should this operate, please investigate the cause of the cut out before resetting (See Troubleshooting).

 The water heater must be filled with water before switching on the immersion heater. Failure to do so will damage the element and void any guarantee on the product.

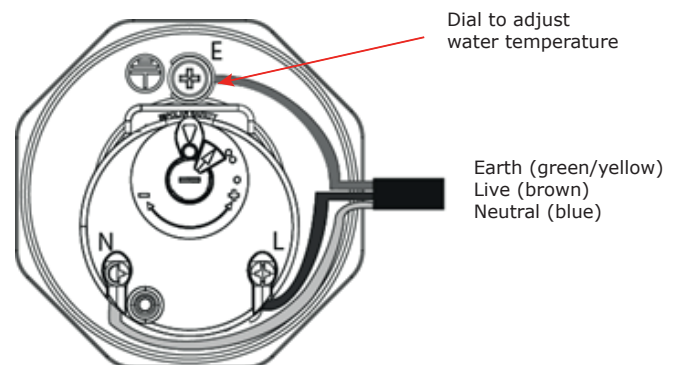

Figure 5: Wiring diagram for Immersion Heater

6.6 Air Connection

The heat pump operates over a large air temperature range (from -7°C to 35°C) using energy from outdoor air. It is essential to correctly design and install the air ducting system to ensure the product operates properly and complies with regulations.

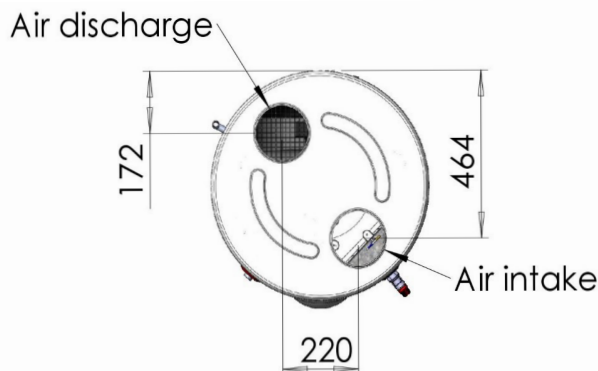

Figure 6: Air intake and Air discharge

The air supply to and from the Edel heat pump water heater must **NOT** extract air from the living space of the dwelling. The air must be supplied to the appliance directly from the outside or from another source outside the thermal envelop of the living space.

The ducting used to connect the air intake and exhaust must be sufficiently insulated to prevent condensation forming. Condensation may result in damage to the appliance and/or building fabric.

 **Dimplex does not take any responsibility for issues caused by poor ducting design or installation.**

Figure 7 provides an example of how the ducting inlet and outlet connections should be installed.

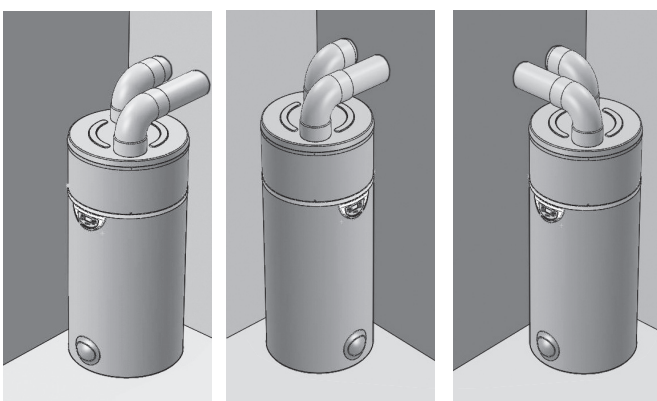



Figure 7: Examples of air connection to the water heater

 **Dimplex does not take responsibility for installation and the operating efficiency of the appliance when installed outside the scope of the guidelines provided in this document.**

6.7 Ducting Design

It is essential to maintain a minimum air flow rate through the ducting for correct operation of the appliance. The nominal mass flow rate must be maintained above 320m³/hr.

For the fan to operate in Fan speed 1, the maximum system pressure drop across the ducting connections must not exceed 100Pa and for Fan speed 2 the maximum pressure drop must not exceed 220Pa



Fan speed 1 will operate when the system pressure drop is minimal as a result of very short duct runs. System efficiency will be slightly increased and the noise level slightly reduced.

NOTE: The system reliability and efficiency will be compromised should the mass air flow rate drop below 320m³/hr.

During the product specification stage, it is essential that the system designer calculated the required total quantity of ducting connections, lengths, bends and terminations to establish an accurate value for total system pressure drop based on the system air flow

6.7.1 Worked Example

A ducting system with the following;

	Item	Qty	ΔP [Pa]	Total [Pa]
Air Intake	2m straight	X 5	4.8	24.0
	90°bend	X 3	12.5	37.5
	External terminal	X 1	51.0	51.0
Air Exhaust	2m straight	X 4	4.8	19.2
	90°bend	X 2	12.5	25.0
	External terminal	X 1	51.0	51.0
Total System Calculated Pressure Drop @ 320m ³ /hr				207.7 Pa

Table 3: Worked example

Note:

- The calculated worked example includes all the necessary ducting components to complete the installation and has resulted in a total system pressure drop of 207.7 Pa at 320m³/hr mass air flow rate. This is acceptable as the pressure drop is below the maximum permissible allowed.
- The pressure drop information provided is for 160mm semi rigid Ubbink ducting, other ducting manufacturers components may be used however the total maximum pressure drop must not exceed the stated values.

6.8 Condensates Draining

The condensates tube should not be directly connected to a drain. It must terminate into open air through a U-bend which has been added and contains water.

- Do not use an elbow on the flexible hose

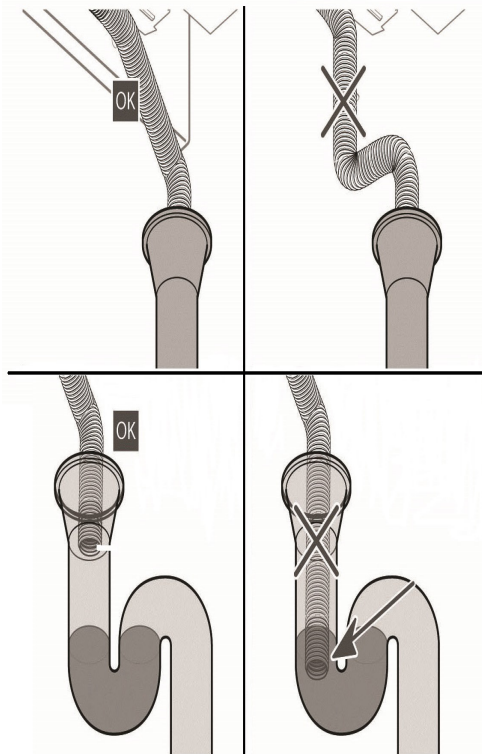

Figure 8: Detailing the correct connection of condensates draining

6.9 Electrical Connections

The power supply should comply with the regulations in the country of installation, as well as the IEE Wiring Regulations.

A means of disconnection which ensure an electrical isolation in Category III conditions should be installed in fixed cabling in compliance with the installation rules.

Protect the appliance with :

- A 13A fused spur or isolator must be installed adjacent to the appliance for mains supply connection.
- A 16A RCBO type C circuit breaker must be fitted at the local consumer unit on the same supply.

If the power supply cable is damaged it must be replaced by a suitably qualified technician or electrician.

6.9.1 Accessing Electrical Connections

To access electrical connections:

- Isolate the electrical connections.
- Remove the cover from the top of the appliance by taking out the screws which fix the lid onto the lower base of the heater.
- Remove the black protective cover from the electronic board.



Only a voltage-free, external connection may be used, or the electronics board may be destroyed.

6.9.1.1 Electricity Provider Contact

To stop the electrical back-up immersion running during peak time, connect the voltage-free contact from your electricity meter to terminal n°1, please refer to Figure 8.

- Contact open = electrical back-up not authorised to run
- Contact closed = electrical back-up authorised to run

If you choose load shedding level 1, the electrical back-up is prevented from running. If you choose load shedding level 0, both the electrical back-up and the heat pump will be prevented from running (see Section 7.10.2.4).

To prevent electrical backup operating during peak hours, if a volt free output is not available from the meter, a timer switch should be used if:

- Switch off = backup not allowed
- Switch on = backup allowed

Only a zero-voltage, external control such as a timer switch should be used (if not, the electronic board could be destroyed).

- Pass a 0.75mm 2-wire cable with crimped ends through a cable gland at the back of the appliance and bring the end of the cable round to the electronic board. The other end of the cable should be connected to the timer switch.
- Insert the 2-wire cable through a grommet on the electronics board.
- Connect the 2-wire cable to "Entrée 1" indicated on the electronic board, having removed the existing red bridge beforehand.

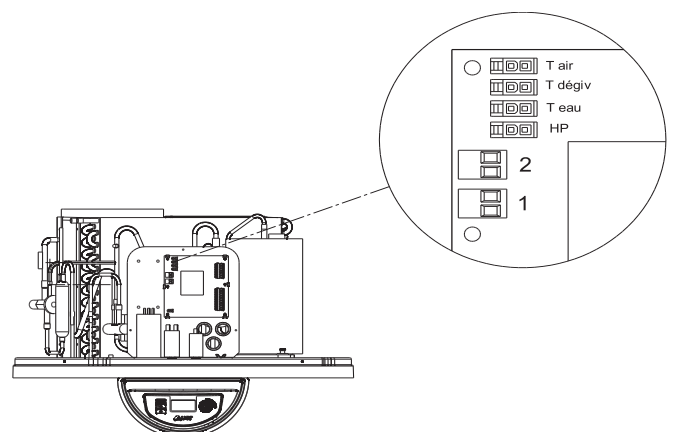

Figure 9: Detailing the electricity provider contact on the electronic board

6.9.1.2 Connecting the PV Function

This function enables the appliance to operate in auto-production mode, which means that it will use the energy produced by the PV function to supply the heat pump as well as the electrical back-up, in order to heat the water in the tank.

The connection is made between the PV Inverter and connectors 1 and 2 on the electronics board.

- Remove the appliance lid.
- Remove the black cover from the electronic board.
- Connect the PV function cable to connector 1 on the electronic board.
- If the PV function regulator has two control contacts, connect them to Entrée 1 and 2 on the electronic board (see Figure 9).
- Terminal 1: a low level of electrical energy is produced by the PV function.
- Terminal 2: a high level of electrical energy is produced by the PV function.

7 Set-Up and Use

7.1 Commissioning

Deterioration risk: The water tank must be filled before the appliance is switched on or connected to a power supply.

At the time of commissioning, complete all relevant sections of the Benchmark Checklist located on the inside back pages of this document.

The following commissioning procedures only detail the required steps to be taken for the potable water loop.

- 1) Before making any mains connections to the inlet control group, flush the mains pipework out to ensure all debris has been removed so as not to damage the strainer within the combination valve.
- 2) Make final mains connection on combination valve and check all connections and joints to

- 3) Before turning on the mains supply to the water heater a hot water tap should be opened, preferably on the same floor or the floor below where the water heater is located.
- 4) Check the pre-charge in the expansion vessel and ensure it is at least 3 bar. Note actual pressure on label on expansion vessel.
- 5) Turn on the supply to the water heater and fill until water runs from the open hot water tap. Continue to flush the system until all debris has been removed.
- 6) Close the hot water tap.
- 7) Check all joints for leaks, even those not having been altered especially when replacing a vented water heater.
- 8) Open temperature and pressure relief valve to ensure proper discharge and check after closing that valve is not dripping.
- 9) Open expansion relief valve to ensure proper discharge and check after closing that valve is not dripping.
- 10) Check all shower outlets, toilet cisterns and other draw off points for leaks or dripping (especially when replacing a vented unit). Open all water outlets to purge air from pipework and ensure proper operation.
- 11) Instruct user in the operation of the unit and hand over this manual advising the owner of annual service requirements.
- 12) Complete the technical data label on the water heater with legible and permanent writing.

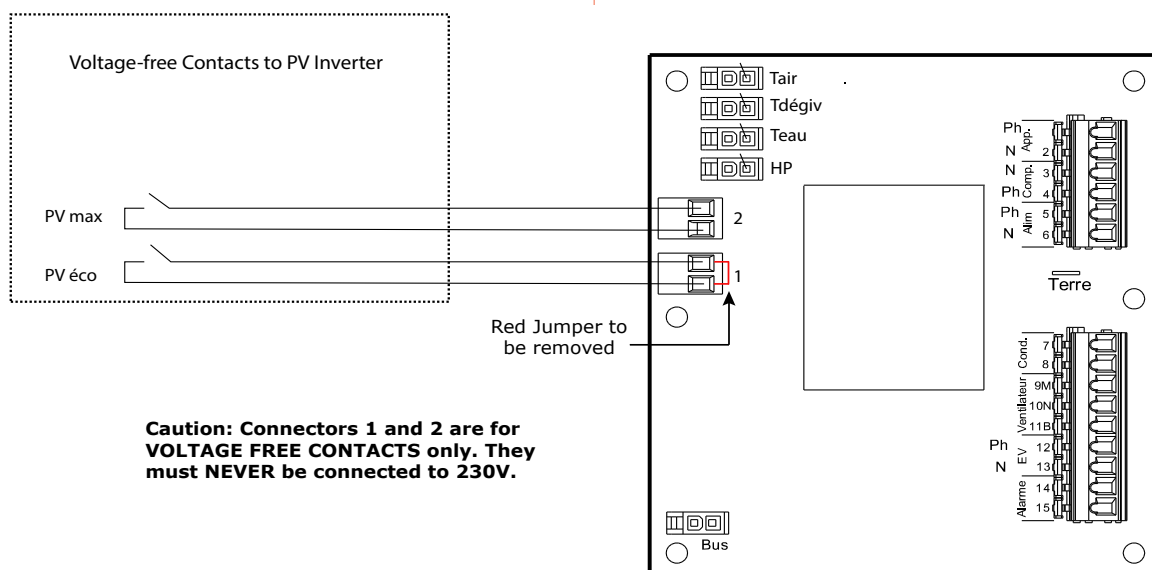

Figure 10: Diagram showing PV connections

7.2 Using your Hot Water Heat Pump

The hot water heat pump mainly operates with the heat pump, as long as the air intake temperature remains in the authorised - 7°C to + 35°C range. Outside of this range, electrical backup ensures that the domestic hot water is heated.

The domestic hot water temperature provided by the heat pump is adjustable up to 60°C. In case of high domestic hot water consumption, the domestic hot water heater has a comfort function which increases the heating capacity when there is less than 1/3 of the tank's volume left at over 38°C (see Section 7.10.2.3). There is also a setting to activate electrical backup if the heating time is too long.

If more domestic hot water is required from time to time, the heat pump water heater has a "Boost" function (activated by the user) which ensures that the water heats to the desired temperature (for example : 50°C) quickly with the help of the heat pump and electrical backup. This function is deactivated as soon as the required temperature is reached. From time to time, check that there are no alerts (in case of an alert, please refer to Section 8.5).

7.3 Control Box

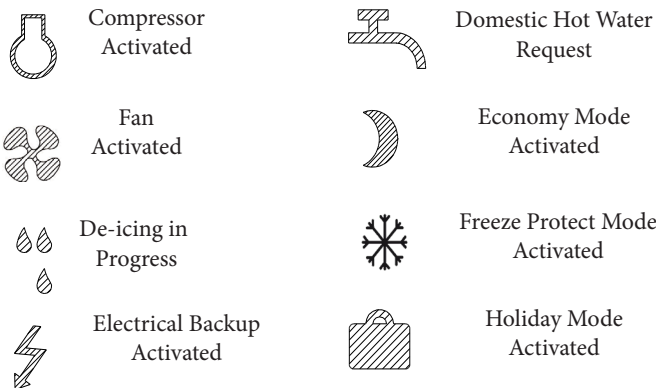
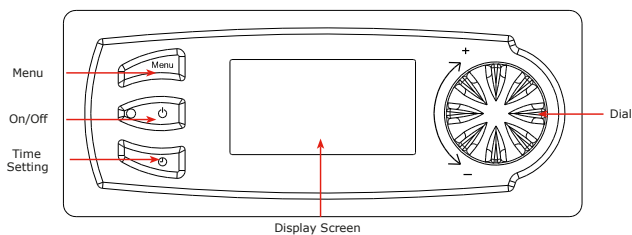

7.4 Setting the Language

The language must be selected when the appliance is turned on for the first time. Turn the dial to the left, select 'English' and press the dial to confirm. The language menu can be accessed at any time.

- Press 'Menu'.
- Turn the dial to scroll through the menu options:

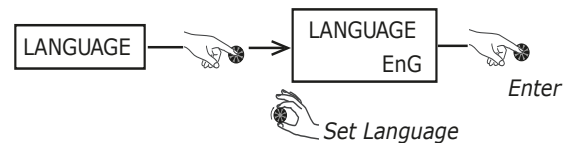

- Press 'Menu' to return to the main screen.

7.5 Setting the Time

- Press 'Clock':

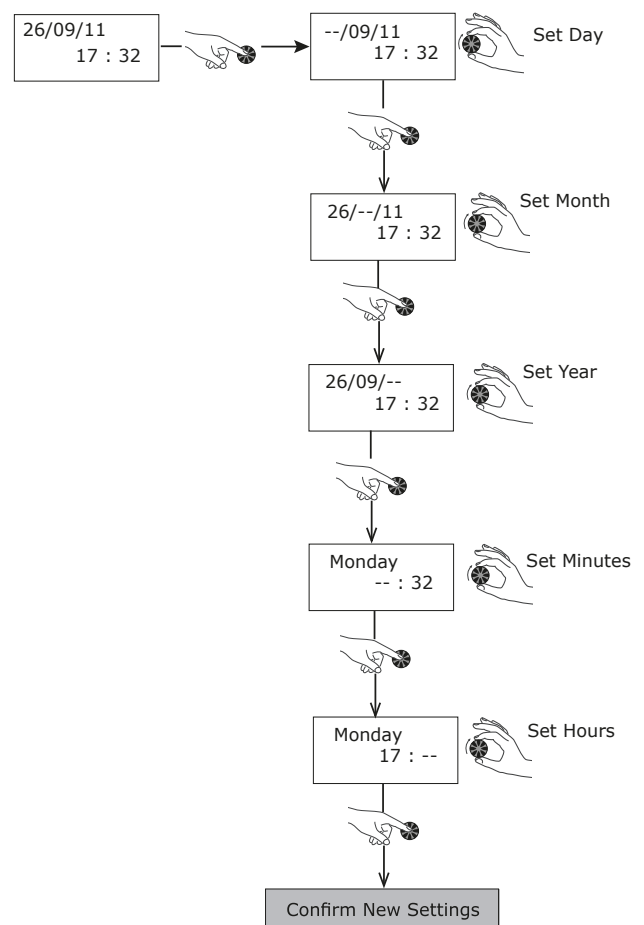

- See section 7.11 for instructions to gain access to installer menu

7.6 Setting the Water Temperature

The water temperature can be adjusted between 30°C and 65°C. The heat pump alone heats the water up until 60°C. Beyond this temperature, up to 65°C, the electrical backup immersion takes over.

- Press 'Menu'.
- Turn the dial to scroll through the menu options:

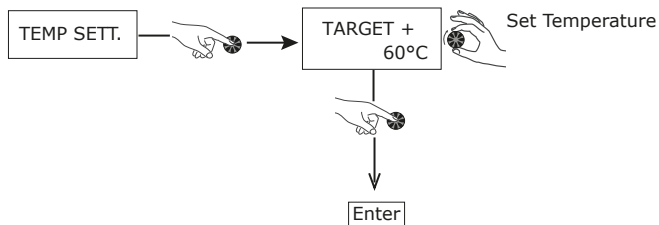

- Press 'Menu' to return to the main screen
- In order to get the best from your heat pump, we recommend that you do not leave the set water temperature too high unless necessary. The default temperature is set at 60°C.

7.7 Holiday Mode

'Holiday' mode puts the appliance on standby whilst the freeze protection mode remains active. This function can be programmed to run between 1 and 99 days and is effective as soon as the number of days has been confirmed.

- Press 'Menu'.
- Turn the dial to scroll through the menu options:

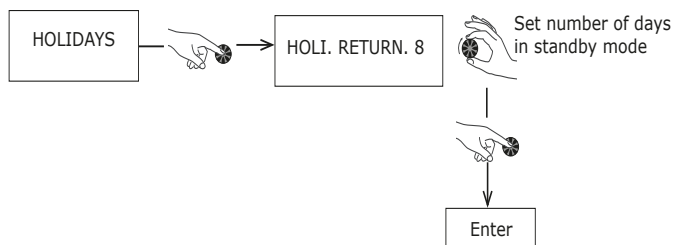

- Press 'Menu' to return to the main screen.

'HOLIDAY' mode switches off automatically at the same time when the number of days set has ended. Throughout the holiday period, the heat pump water heater shows 'Holi. Return.' on the display screen, as well as a countdown of the days.

-To cancel holiday mode select 0 days

7.8 BOOST Function (for occasional use)

The 'BOOST' function temporarily uses both the immersion heater and the heat pump to increase the temperature during a heating cycle. The "electrical backup" symbol flashes while it is activated.

- Press 'Menu'.
- Turn the dial to scroll through the menu options:

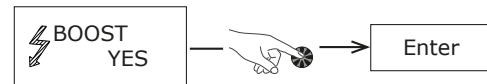

- Press 'Menu' to return to the main screen

The 'BOOST' function is automatically deactivated as soon as the set temperature is reached (end of heating cycle).

- 'BOOST' can be cancelled by selecting 'no' in the menu

7.9 Electric Mode (to operate with electrical backup)

Electric mode uses only the immersion heater to heat the water in the heat pump water heater. It provides a back-up option if for any reason the heat pump is not running (ducting not yet connected, dusty renovation work being carried out near the appliance....). This can be turned off if preferred.

- Press 'Menu'.
- Turn the dial to scroll through the menu options:

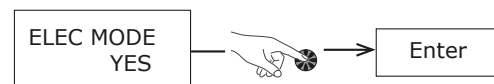

- Press 'Menu' to return to the main screen.

7.10 Programming

Programming enables you to define the periods of time the appliance runs in 'Economy', 'Comfort' or 'Off' mode (freeze protection mode). Electrical backup is not allowed while the appliance is in 'Economy' mode.

To access the program menu:

- Press the 'Clock'.
- Press down for 3 seconds until the screen display 'Settings'.

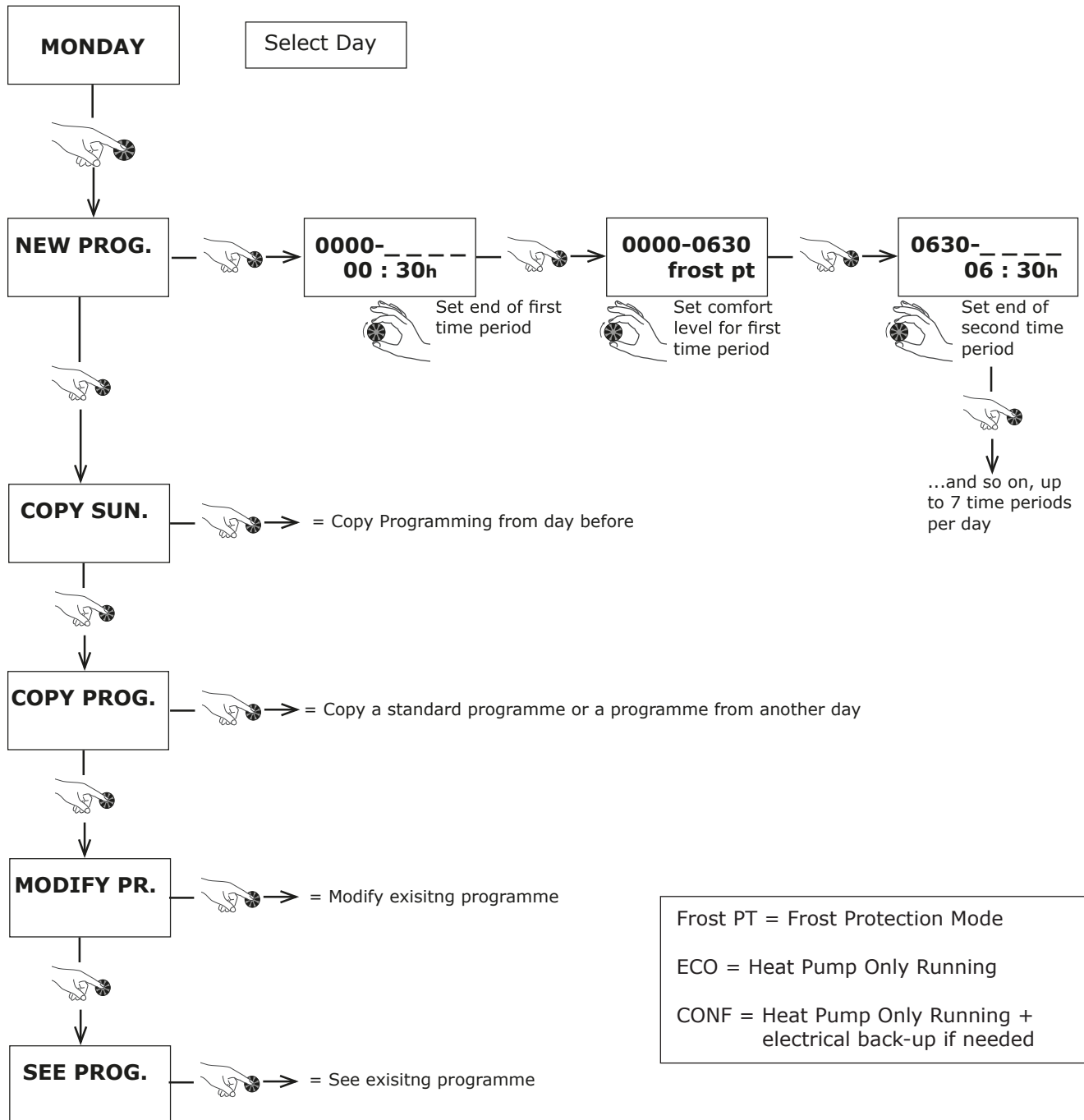

Heating time for the tank varies according to the outdoor temperature.

7.11 Installer Menu

It may be necessary to adjust certain settings to optimise the performance of the heat pump water heater, depending on how the appliance is installed.

Accessing the Installer Menu:

- Press 'Menu' and 'clock' simultaneously
- Turn the dial until the screen displays 'Inst. Menu'
- Press the 'Clock' and 'Menu' buttons simultaneously
- Keep both buttons pressed down until the screen goes blank



To adjust installation settings



To go back to default settings



To display temperatures of sensors and inlets default settings

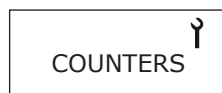

To see the meters running, count start-ups etc.



To display locking settings



To display PV settings

7.11.1 PV Mode

Setting	Description	Unit	Range	Factory setting
MODE PV	Photovoltaic mode activated	-	yes no	no
PRIORITY	Anti-legionellosis cycle time intervals	-	yes no	yes

- PV mode must be activated in the controller to take account of connections as described in Section 6.9.1.2. If the PV mode regulator is connected to connectors 1 and 2 on the electronics board.
 - The electrical energy which is produced is stored in the form of hot water. The PV function can be set to two different levels of production.
 - PV ECO = the lower level of photovoltaic electricity production. The heat pump generates a higher water temperature. The hot water temperature must be somewhere in-between the ordinary hot water temperature and 60°C (factory setting: 60°C).
 - PV MAX = the higher level of photovoltaic electricity production. The heat pump and electrical back-up generate a higher water temperature. The hot water temperature must be somewhere in between the eco mode hot water temperature and 65°C (factory setting: 65°C).

- Turn the dial to set the mode:

MENU → INST. MENU → PV MODE

- Select 'Yes'.

- Press the dial to confirm.

- Press the 'Menu' key.

- Set the desired domestic hot water temperature.

- Turn the dial to select the primary function:

MENU → INST. MENU → PV MODE → PRIORITY

Yes: the signals from connectors 1 and 2 take precedence over eco, holiday and frost protection modes.

No: frost protection and eco modes take precedence over the signals from connectors 1 and 2.

N.B:

If **PV mode** is chosen as the primary function, the domestic hot water will also be heated during non-selected time periods, e.g. in **holiday mode** and outside of the programmed time slots.

If you only wish the domestic hot water to be heated during authorised time slots, adjust the setting to "No".

- Press the dial to confirm.

- The load shedding function will not be available.

7.11.2 Adjusting the Operating Settings

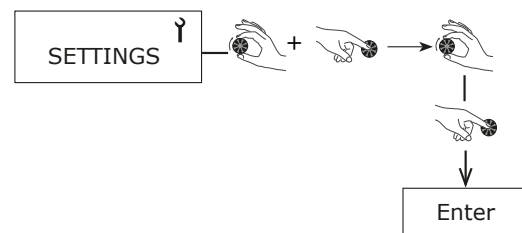

Setting	Description	Unit	Options	Factory Setting
ANTI-BACT.	Time interval for anti-legionella cycle	Days	No - 99	No
FAN MODE	Ventilation mode	-	1, 2 or 3	1
T°C MINI	Min. temp. for electrical backup	-	No or 43°C	No
SHEDDING	Load shedding level	-	0, 1 or 2	1
MAX. TIME	Max. heating time	Hours	No, auto 1 to 24	No

Table 4: Settings

- Press 'Menu' twice to return to the main screen.

7.11.2.1 Anti-Bacteria (Anti-Bact)

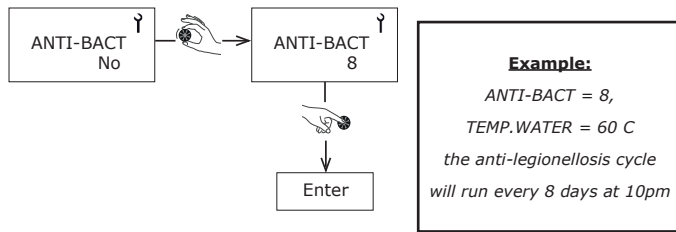

- Press 'Menu' twice to return to the main screen.

Factory Setting = No

- No legionella cycle except the return from vacation and during exit frost over 3 days.
- During the legionella cycle the water temperature is raised to 60°C by the heat pump.
- If the hot water is already set to 60°C (See Section 7.5) then legionella cycle will not run as temperature is already obtained.
- If a cycle is interrupted by loss of electrical power then the cycle will run at the next cycle period.
- The frequency of day can be adjusted according to number of days
- During the anti-legionellosis cycle the temperature is raised between 55°C and 70°C

7.11.2.2 Fan Mode

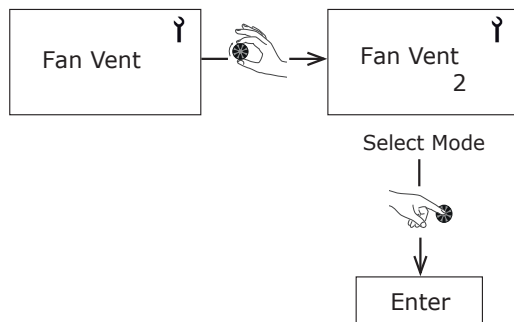

- Press 'Menu' twice to return to the main screen.

Factory Setting = 1

- Mode 1 = Standard mode, automatic ventilation.
- Mode 2 = Manual mode, forced ventilation.
- Mode 3* = Ventilation during the heating of the water and ventilation controlled by thermostat. Thermostat is connected to input of the electronic card in the heat pump water heater (see wiring diagram).

* In the case of activation of the PV mode, controlled ventilation (Mode 3) is not available.

* The electric back-up immersion heater will activate until the water temperature reaches 43°C. The heat pump will complete the remaining charge to set temperature.

7.11.2.3 Minimum Temperature

It is possible to allow the operation of the immersion heater along with the heat pump to prevent the water temperature falling below a minimum comfort temperature of 38°C. The immersion will then heat the water to 43°C, once this temperature has been reached the immersion will stop and the heat pump will finish the complete heating of the water heater.

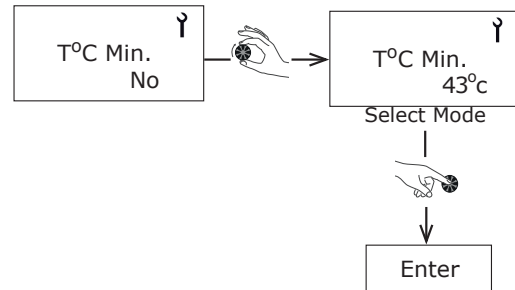

- Press 'Menu' to return to the main screen.
- By default this is not active.
- In case of load shedding, the function <T⁰C Mini> is not active.

7.11.2.4 Shedding

You can select which items are restricted from running during load shedding (immersion heater or heat pump).

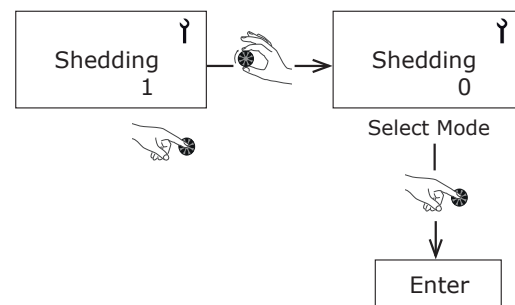

- Press 'Menu' to return to the main screen.

If the power contact is open:

- Mode 0 = Nothing is allowed to run.
- Mode 1 = Only the heat pump will operate.
- Mode 2 = Heat pump and boost are will operate (neutralising the peak hours).

If the PV function is activated then the load shedding from the voltage-free contact (Entrée 1/2) is not possible. In this case it is necessary to go through the programme scheduling (See Section 7.9).

7.11.2.5 Maximum Time

A period of time can be chosen where the electrical back-up will run at the same time as the heat pump to speed up the heating of the water in the tank. If you choose **Max. Time= AUTO**, the heating time is limited to 5 hours maximum.

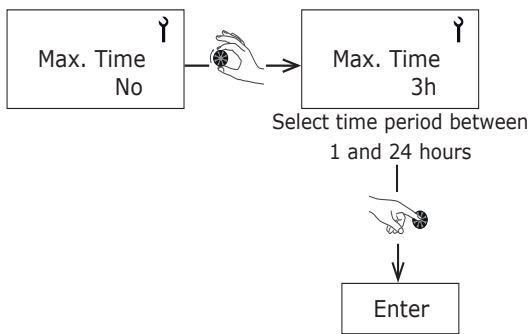

- This function is deactivated by default.
- Press 'Menu' to return to the main screen.

7.11.3 Locking the Keyboard

Permanent and automatic locking

The "Locking" option enables you to create two possible levels of locking for accessing the menus. In the "Installer" menu, turn the dial to "Locking".

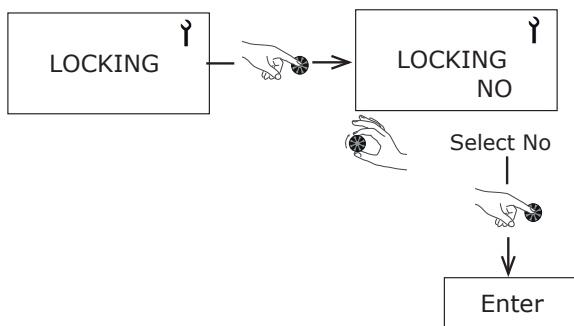

NO = Locking is not activated but manual locking is possible by pressing 'Menu' for 3 seconds.

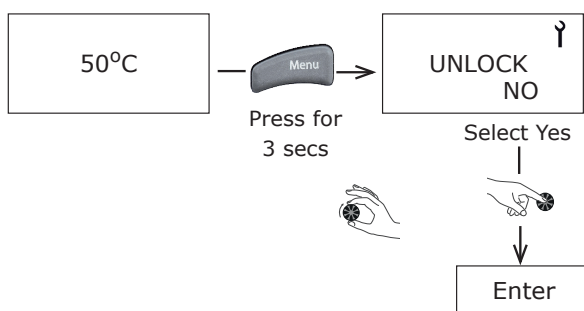

AUTO = To lock menu access with temporary unlocking (60) sec, press 'Menu' for 3 seconds.

Manual Locking from the Main Screen

Without gaining access through the 'installer' menu and provided that locking settings are not already in place.

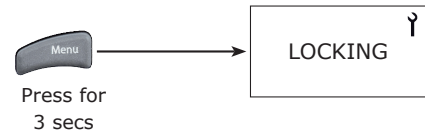

- Press 'Menu' to return to the main screen.

7.11.4 Resetting Parameters

Resetting the parameters enables you to go back to the default settings. Go to the 'Installer' Menu and turn the dial to 'Reset'.

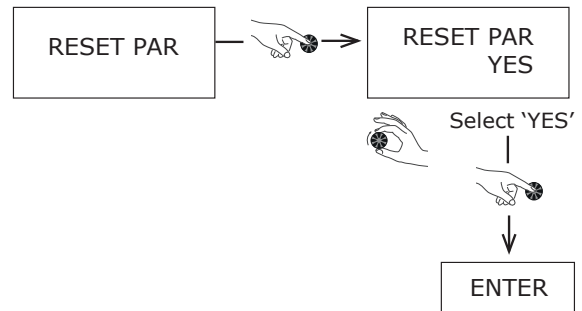

7.11.5 Reading Display

The 'Read Data' menu shows you, in real time, the information given by sensors. To access hold the dial for 3 seconds until 'Display' menu shows, turn the dial to select the desired display.

Display	Description	Reference on electronics board
WATER	Domestic hot water temperature in lower part of tank	Teau
AIR	Temperature of heat pump air intake	Tair
EVAP.	Temperature of heat pump evaporator (expansion valve outlet)	Tdégiv.
CLOCK SWITCH	Off-peak hours switch (0 = on; 1 = off)	heures creuses
FAN CONTR.	Fan control switch (0 = on; 1 = off)	hygrostat
PV ECO	Contact input 1 0 = open 1 = closed	1
PV MAX	Contact input 2 0 = open 1 = closed	2

The temperature which is permanently displayed on the screen is the set temperature and does not necessarily indicate the temperature of the water immediately available in the tank.

7.11.6 Counters (Meters)

The 'Counters' menu shows the number of start-ups from the heat pump and the electrical backup. In the 'Installer' menu, turn the dial to 'Counters'.

Counter No.1: Number of start-ups from the heat pump.

Counter No. 2: Number of start-ups from the electrical backup.

Counter No. 3: Cumulated heated pump running time.

8 Maintenance

The maintenance of this appliance covers the critical areas of the Domestic Hot Water Cylinder, the Heat Pump Module, Air Connections and Electrical Connections.



All maintenance on this product must be undertaken by a suitably qualified and trained technician.

8.1 DHW Cylinder

After servicing, complete the relevant Service Record section of the Benchmark Checklist located on the inside back pages of this document. To meet with warranty requirements the cylinder must be serviced annually.



When draining the tank, ensure that there is a large enough air inlet at the top to avoid any depression in the tank; failure to do so will invalidate the warranty.

1. Draw some water from cold water tap and retain in container.
2. Isolate cold water mains supply from cylinder.
3. Briefly open temperature and pressure relief valve to assure safe discharge and check that valve is not dripping when closed.
4. Briefly open the expansion relief valve to assure safe discharge and check that valve is not dripping when closed. The expansion relief valve should be operated regularly to remove lime deposits and to verify that it is not blocked.
5. Open hot water tap and release remaining pressure from unit.
6. If the system is drained completely for an internal inspection, ensure the hot water tap remains open, connect a hose to the drain valve and ensure a safe discharge.
7. Note the set pressure of the pressure reducing valve. Remove cartridge and clean strainer in water provided in container. Re-assemble pressure reducing valve ensuring the correct pressure is set.
8. Periodically the immersion heater should be removed cleaned and the unit flushed out. If the system is drained for internal inspection Check the O-ring seal for damage and replace if necessary. A torque of 40 Nm is recommended when tightening up the immersion after it has been removed and refitted.
9. Check electrical wiring connections and the condition of the cable of the immersion heater and the thermostat.
10. The immersion heater boss can also be used for access to view the internal components of the cylinder.
11. Re-commission unit (see chapter 7.1).

8.2 Heat Pump



Any work on the refrigerant circuit must be carried out by a qualified professional with an F Gas Category 1 certificate of aptitude.



It is strictly prohibited to release refrigerant into the atmosphere. The refrigerant must be collected before any work is carried out on the circuit.

1. Remove insulation from ducting as well as the ducting itself and thus remove the hood from the unit to expose the compressor, heat exchanger etc.
2. Check the compressor for ice formation.
3. Check the circuit for leak-tightness by carrying out a test of the refrigeration components with an appropriate R290 sniffer.
4. Check whether the components of the refrigerant circuit show any signs of rust or traces of oil.
5. Check the unit's components for wear or defective items.
6. Inspect for build-up of debris in ducting and hood, remove if necessary.

7. The heat exchanger should be examined for dirt and dust and cleaned with warm water carefully to avoid damaging the fins. Make sure that the air can circulate between the fins and around the product.
8. Check that the cables are securely seated on the connection terminals.
9. Check that the fan runs freely.
8. Regularly checked the electrical connections as part of the maintenance schedule, to ensure the wires remain in good condition and terminations remain secure. Ensure any spare parts used during maintenance of the product are an authorised spare part and meet the manufacturers' requirements.

8.3 Air intake & Exhaust

1. Both the exhaust and air intake vents must be inspected and cleared of any debris stuck in the vents.
2. Ensure the evaporator is checked at least once a year, more depending on the cleanliness of the air

8.4 Heat Pump Condensation

1. To check that condensation is draining correctly:
 - Remove upper cover (see Section 6.9.1).
 - Check for blockages in the drainage hole.
 - Clean the condensate recovery container, were deposits from air intake may have gathered.
 - Clean the flexible draining hose.
2. The pressure limiting device must be switched on regularly to eliminate limescale and check for blockages.
3. Check that all hydraulic connections on the heat pump water heater are watertight.
4. The condensate drain should be inspected to ensure the red plug has been removed and unrestricted draining of condensation is allowed.

8.5 Electrical Connections

Incorrectly made electrical connections can result in over-heating and hence a fire risk. When installing or servicing the product, please ensure the wiring is adequate to minimise risk of overheating. Please ensure you have:

1. Remove the dust from power supply connections.
2. Used the correct type and cross-sectional area cable to meet manufacturer and Wiring Regulation requirements.
3. When stripping the insulation from the individual conductors, taken care to not damage the strands of the conductor wire, which would reduce the cross-sectional area of the conductor.
4. Ensured the conductors are tightly and securely connected to the controls or immersion heater
5. Ensured the bared conductors are correctly inserted into the terminals, to avoid bearing on the insulation sleeving or only partially clamping the conductors.
6. Securely anchored the supply cable using the means provided to avoid exerting any external strain to the cable and hence to the terminals.
7. Checked to ensure the product is earthed correctly; the Live and Neutral connections are to the correct terminals, and the Residual Current Device (RCD) operates correctly.



Waste electrical product should not be disposed of with household waste. Please recycle where facilities exist. Check with your Local Authority or retailer for recycling advice.

8.6 Troubleshooting

Issue	Check
<u>The Heat Pump is not working</u>	<ul style="list-style-type: none"> - That the desired water temperature is higher than the temperature of the water in the tank. - There is power supply to the appliance. - The the green light is on. - That the appliance is not in holiday mode (see Section 7.6) - That the air intake or ambient temperature is under -7°C or over $+35^{\circ}\text{C}$. - That the timer has not been programmed to stop the appliance operating ('Economy' light will be on (see Section 7.2). - If an error message is displayed on the screen (see Section 8.5).
<u>No Hot Water</u>	<ul style="list-style-type: none"> - That the volume consumed is not higher than the volume in the tank. - The time period the appliance operates is not too short (12hrs minimum if connected to piping). - The water temperature is not set too low.
<u>Condensates are not draining</u>	<ul style="list-style-type: none"> - The draining system for dirt or blockages: Remove the cover (see Section 6.9.1) and check the opening. - That tubes do not have bends or "U" shapes that can collect water. - That the end of the tube is not blocked off and has access to open air.
<u>Electrical backup is not working</u>	<ul style="list-style-type: none"> - That your electricity provider or your timer is not preventing the appliance from functioning, 'Economy' symbol should be on (see Section 7.2). - A heat-limiting safety thermostat for electrical backup has not been activated after over-heating ($>85^{\circ}\text{C}$). If this is the case, reset it. - Before resetting, check: <ul style="list-style-type: none"> • that the heating element does not have limescale. • clean or replace if necessary.

Table 5: Troubleshooting

Do not adjust the settings on the thermostat.

Reset button (85°C) on thermostat

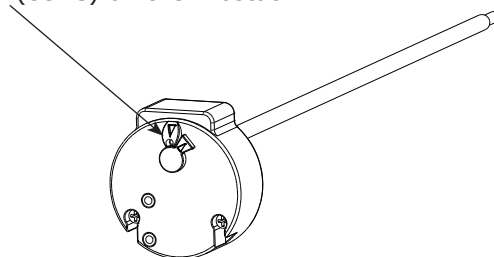

8.7 Spare Parts

















Description		Part No
22mm x 3bar Inlet control group		R00041-1
Inlet control group PRV cartridge		R00009-1
18 litre expansion vessel		R00045-2
Expansion vessel fixing kit		R00094-2
DN16 3/4" BSP x 1000 flex pipe		R00095-1
1/2" BSP T&P valve		R00020-1
15 x 22 straight PE tundish		R00047-1
Temp. sensor - 25°C -		1243950
C3S PCB Controller		1244096
70-85°C Thermostat		4992886
1200W electric heating element		1243926
Electric heating seal		1657452
PCB +Display +PGM +Cable		4592570
Display Screen Dial		1758866
Thread sealant		R00836-1
Air Source Heat Pump Water Heater Installation & User Instructions manual		RD00662-3

Table 6: Edel Air Source Water Heater Spare Part List

8.8 Error Message Codes: Errors, Solutions and Operating in case of Error

N.B Errors can be dismissed by briefly pressing the dial (manual reset).

Display	Error	Probable causes	Solutions	Temporary operation measures while waiting for problem to be solved
MEMO/ BUS	<ul style="list-style-type: none"> Electronic board defect. Bus wire defect. Display screen defect. 	<ul style="list-style-type: none"> Voltage too high on electrical network. Cabling error during electrical connection (connection to electricity provider or moisture sensor...). Damage during transportation. 	<ul style="list-style-type: none"> Replace main electronics board or; Replace display screen board. 	<ul style="list-style-type: none"> Appliance non-functional.
T_AIR	<ul style="list-style-type: none"> Air temperature sensor defect (Temperature of air taken in). 	<ul style="list-style-type: none"> Sensor not functioning. Sensor unplugged from board. Sensor cable damaged. 	<ul style="list-style-type: none"> Replace sensor. 	<ul style="list-style-type: none"> Heat pump non-functional. Electrical backup heats water to 43°C (min 38°C).
T_DE-FROST	<ul style="list-style-type: none"> Evaporator sensor defect (de-icing temperature). 	<ul style="list-style-type: none"> Sensor not functioning. Sensor unplugged from board. Sensor cable damaged. 	<ul style="list-style-type: none"> Replace sensor. 	<ul style="list-style-type: none"> Heat pump non-functional. Electrical backup heats water to 43°C (min 38°C).
T_water	<ul style="list-style-type: none"> Tank water sensor defect. 	<ul style="list-style-type: none"> Sensor not functioning. Sensor unplugged from board. Sensor cable damaged. 	<ul style="list-style-type: none"> Replace sensor. 	<ul style="list-style-type: none"> Heat pump non-functional.
Clock	<ul style="list-style-type: none"> Clock/timer defect. 	<ul style="list-style-type: none"> Voltage too high on electrical network. Damage during transportation. 	<ul style="list-style-type: none"> 1-Press «clock settings» and set date and time. 2-If the error message still does not disappear, replace the electronics board. 	<ul style="list-style-type: none"> Programmed heating periods are no longer valid: the water is maintained continuously at the standard set temperature (if no signal or control is connected to the «external control» switch).
OVER PRESS.	<ul style="list-style-type: none"> Heat pump pressure too high. 	<ul style="list-style-type: none"> No water in tank. Water is too hot (>75°C) Water sensor removed from tank. Defective water sensor. 	<ul style="list-style-type: none"> Check that the tank has been properly filled with water and purged of air. Change the water sensor Check that the water sensor is in the right position in the tank. 	<ul style="list-style-type: none"> Heat pump is non-functional. Resets automatically. Authorised to run on backup.
FREQ. DEFRO	<ul style="list-style-type: none"> De-icing too often. 	<ul style="list-style-type: none"> Insufficient airflow. Air inlet / outlet blocked. Ventilation duct blocked. Air duct is too long or has too many elbows. Evaporator clogged. 	<ul style="list-style-type: none"> Check that air is circulating properly throughout the piping circuit. Check pipe lengths: <ul style="list-style-type: none"> -10m total of flexible hose. -20m total of rigid piping. Check any filters on air ducts. Check evaporator is clean. 	<ul style="list-style-type: none"> Heat pump non-functional. Electrical backup heats water to 43°C (min 38°C).
LOW PRES	<ul style="list-style-type: none"> Heat pump pressure too low. 	<ul style="list-style-type: none"> Insufficient airflow. Air inlet / outlet blocked. Ventilation duct blocked. Fan blocked or out of order. Evaporator clogged. Ice on evaporator. 	<ul style="list-style-type: none"> Check the fan is working. Check that air is circulating properly throughout the piping circuit. Check pipe lengths: <ul style="list-style-type: none"> -20m total of rigid piping. Check any filters on air ducts. Check evaporator is clean. 	<ul style="list-style-type: none"> Heat pump non-functional. Electrical backup heats water to 43°C (min 38°C).

Display	Error	Probable causes	Solutions	Temporary operation measures while waiting for problem to be solved
OVER-HEAT	<ul style="list-style-type: none"> Domestic hot water overheat (water temperature >85°C) 	<ul style="list-style-type: none"> Defective water sensor Water sensor removed from tank 	<ul style="list-style-type: none"> Check that sensor is in the right position in the tank 	<ul style="list-style-type: none"> Heat pump is non-functional Resets automatically
ERR 01	<ul style="list-style-type: none"> Incorrect temperature sensor reading. 	<ul style="list-style-type: none"> The air and de-icing sensors are the wrong way round on the electronics board. The de-icing sensor and water sensors are the wrong way round on the electronics board. The de-icing sensor is connected to the air input, the air sensor is connected to the water input, the water sensor is connected to the de-icing input. 	<ul style="list-style-type: none"> Reposition the temperature sensors correctly on the main electronics board. 	<ul style="list-style-type: none"> Heat pump non-functional.
	<ul style="list-style-type: none"> Incorrect reading from the de-icing sensor. 	<ul style="list-style-type: none"> The de-icing sensor is not properly connected to the tube and is measuring air. 	<ul style="list-style-type: none"> Reposition the de-icing sensor properly in the tube. 	
	<ul style="list-style-type: none"> The heat pump has run out of gas. 	<ul style="list-style-type: none"> There is a leak on the refrigerant circuit. 	<ul style="list-style-type: none"> Find and repair the leak before filling the refrigerant circuit. 	
	<ul style="list-style-type: none"> The expansion valve is not working. 	<ul style="list-style-type: none"> The expansion valve is damaged or broken due to work being carried out on the appliance or it being in contact with a part which vibrates. 	<ul style="list-style-type: none"> Replace expansion valve. 	
ERR 01	<ul style="list-style-type: none"> The compressor is not working and safety temperature is activated. 	<ul style="list-style-type: none"> Weakness in compressor. 	<ul style="list-style-type: none"> Replace compressor. 	
	<ul style="list-style-type: none"> Incorrect temperature sensor readings. 	<ul style="list-style-type: none"> The air and water sensors are the wrong way round on the electronics board. The de-icing sensor is connected to the air input, the air sensor is connected to the water input, the water sensor is connected to the de-icing input. 	<ul style="list-style-type: none"> Reposition the temperature sensors correctly on the main electronics board. 	<ul style="list-style-type: none"> Appliance non-functional.
ERR 02	<ul style="list-style-type: none"> Incorrect temperature sensor readings. 	<ul style="list-style-type: none"> The de-icing sensor is connected to the air input, the air sensor is connected to the water input, the water sensor is connected to the de-icing input. 	<ul style="list-style-type: none"> Reposition the temperature sensors correctly on the main electronics board. 	<ul style="list-style-type: none"> Appliance non-functional.
ERR 03	<ul style="list-style-type: none"> Incorrect temperature sensor readings. 	<ul style="list-style-type: none"> The de-icing sensor is connected to the air input, the air sensor is connected to the water input, the water sensor is connected to the de-icing input. 	<ul style="list-style-type: none"> Reposition the temperature sensors correctly on the main electronics board. 	<ul style="list-style-type: none"> Appliance non-functional.
ERR 04	<ul style="list-style-type: none"> Incorrect de-icing and water sensor readings. 	<ul style="list-style-type: none"> The de-icing sensor and the water sensor are the wrong way round on the electronics board. 	<ul style="list-style-type: none"> Reposition the temperature sensors correctly on the main electronics board. 	<ul style="list-style-type: none"> Heat pump non-functional.
ERR 08	<ul style="list-style-type: none"> Wrong measure on de-icing sensor. 	<ul style="list-style-type: none"> De-icing sensor is defective. 	<ul style="list-style-type: none"> Replace de-icing sensor. 	<ul style="list-style-type: none"> Product runs in alternative mode with heat pump.
ALARM EPRO	<ul style="list-style-type: none"> The display screen electronics board has a memory problem. 	<ul style="list-style-type: none"> The display screen electronics board is damaged. 	<ul style="list-style-type: none"> Replace display screen electronics board. 	<ul style="list-style-type: none"> Appliance non-functional.

*DHW = Domestic Hot Water

Table 7: Errors

9 Warranty

The tank is guaranteed against breakage for a period of five years, starting from the date the appliance was activated, if the warranty voucher was sent back to the manufacturer. In the absence of this document, the date of manufacture will be used to determine the start date. If the tank is broken, the whole appliance will be replaced.

The other parts are guaranteed for a two year period starting from the date the appliance was activated, if the warranty voucher was sent back to the manufacturer. In the absence of this document, the date of manufacture will be used to determine the start date.

The appliance is guaranteed against all manufacturing defects, provided that it was installed by a qualified professional using our instruction manuals, the C15-100 standard for electrical connections and the plumbing DTU 60-1 additional clause 4 for domestic water. A defective part does not warrant the whole appliance being replaced.

The warranty only extends to parts which we identify as having been defective at manufacture. If necessary, the part or product should be returned to the manufacturer but only with prior agreement from our technical department. Labour, transport and packaging costs are the responsibility of the user. Repairs on a device will not result in compensation. The parts warranty ends at the same time as the appliance warranty.

The warranty only applies to the appliance and its components and excludes any part or installation external to the appliance. Regular maintenance of the appliance by a trained professional is essential for ensuring sustained use and durability. In the absence of regular maintenance, the warranty will not apply. If an appliance is presumed to have been the cause of any damage, the appliance and the damage must be left as they are and not tampered with.

9.1 Warranty Limits

9.1.1 General Information

Please read the following statements carefully as it affects your warranty.

Please ensure that the installer has fully completed the Benchmark Checklist on the inside back pages of this document and that you have signed it to say that you have received a full and clear explanation of its operation. The installer is legally required to complete a commissioning checklist as a means of complying with the appropriate Building Regulations Part G3 (England and Wales), Part P of Northern Ireland and Section 6 of Scotland.

All installations must be notified to Local Area Building Control either directly or through a Competent Persons Scheme. A Building Regulations Compliance Certificate will then be issued to the customer who should, on receipt, write the Notification Number on the Benchmark Checklist.

This product should be serviced annually to optimise its safety, efficiency and performance. The service engineer should complete the relevant Service Record on the Benchmark Checklist after each service.

The Benchmark Checklist will be required in the event of any warranty work.

The warranty does not apply to defects or damage caused by situations or events such as:

- Misuse, abuse, negligence, improper transport or handling.
- Incorrect installation, or installation which has been carried out without following the instructions in the manual and user guide.
- Insufficient maintenance.
- Modifications or changes carried out on the appliance.
- Impacts from foreign objects, fire, earthquakes, floods, lightning, ice, hailstones, hurricanes or any other natural catastrophe.
- Movement, imbalance, collapse or settling of the ground or the structure where the appliance is installed.
- Any other damage which is not due to defects in the product.

The heat pump water heater is not guaranteed against:

- Variations in colour of the appliance or damage caused by air pollution, exposure to chemical elements or changes brought about by bad weather conditions.
- Dirt, rust, grease or stains which occur on the surface of the appliance.

9.1.2 Exclusion from Warranty

9.1.2.1 Use

Cases where warranty (unlimited) is void :

- Water supply being other than cold domestic water, (such as rainwater or water from a well), or which has particularly hostile or abnormal properties which do not comply with the national rules and current standards (DTU 60 - 1 additional clause 4, hot water).
- The appliance being switched on before it is filled.

9.1.2.2 Handling

Cases (unlimited) where warranty is void:

- Any damage sustained by impacts or falls during handling after delivery from the factory.
- Deterioration in the condition of the appliance after handling where the instructions in the manual have not been followed.
- Damage occurring in the appliance when it has been switched on less than an hour after it has been leaning to the side or laid flat.

9.1.2.3 Installation Site

Cases (unlimited) where the warranty is void:

- Placing the appliance where it can be subject to ice or other bad weather conditions.
- Non-compliance with the instructions in the manual when installing the appliance.
- Installing the appliance on a surface which cannot bear its weight when it contains water.
- Installing the appliance in a room with surface area of less than 20m² where there is no piping for air intake and rejection.
- Installing the appliance at a tilted angle which does not allow condensates to flow out correctly.

Costs incurred by access difficulties are not the manufacturer's responsibility.

9.1.2.4 Electrical Connections

Cases (unlimited) where the warranty is void:

- Faulty electrical connection which does not comply with the current national installation standards.
- Not following the connection diagrams in the instruction manual.
- Power supply being significantly under or over the required voltage.
- Failure to comply with supply cable sections.
- Absence of, or insufficient, electrical protection throughout the appliance (fuse / circuit-breaker, grounding etc).
- Damage which results from deactivating the electrical backup thermostat and / or the heat pump.

9.1.2.5 Hydraulic Connections

Cases (unlimited) where warranty is void:

- Inverting the hot/cold water connections.
- Water pressure being higher than 6 bars.
- Absence of, incorrect fitting of, or obstruction of pressure relief valve.
- Not fitting the pressure relief valve directly onto the cold water inlet on the appliance.
- Fitting a pressure relief valve which does not comply with the current national standards.
- Installing a previously-used pressure-relief valve.
- Tampering with the pressure-relief valve.
- Abnormal levels of corrosion caused by an incorrect hydraulic connection (direct contact between iron and copper) without a sleeve (cast iron, steel or insulator).
- External corrosion caused by the piping not being correctly sealed or condensates not draining off properly.
- Improper connection of the condensates recovery system.

No claim for compensation may be made for damage which has occurred as a result of not fitting thermostatic mixing valves.

9.1.2.6 Accessories

The warranty does not cover defects resulting from:

- fitting accessories which do not comply with our recommendations,
- using accessories which were not provided by us.

9.1.2.7 Maintenance

Cases (unlimited) where the warranty is void:

- Non-maintenance of the appliance and in particular the anode not being replaced in time.
- Non-maintenance of the pressure-relief valve, resulting in excessive pressure.
- Non-maintenance of the evaporator or the condensates draining system.
- Abnormal levels of limescale on heating elements or safety devices.
- Not using parts supplied by the manufacturer.
- Protective outer casing being subjected to any external damage.

10 Technical Data and Product Fiche

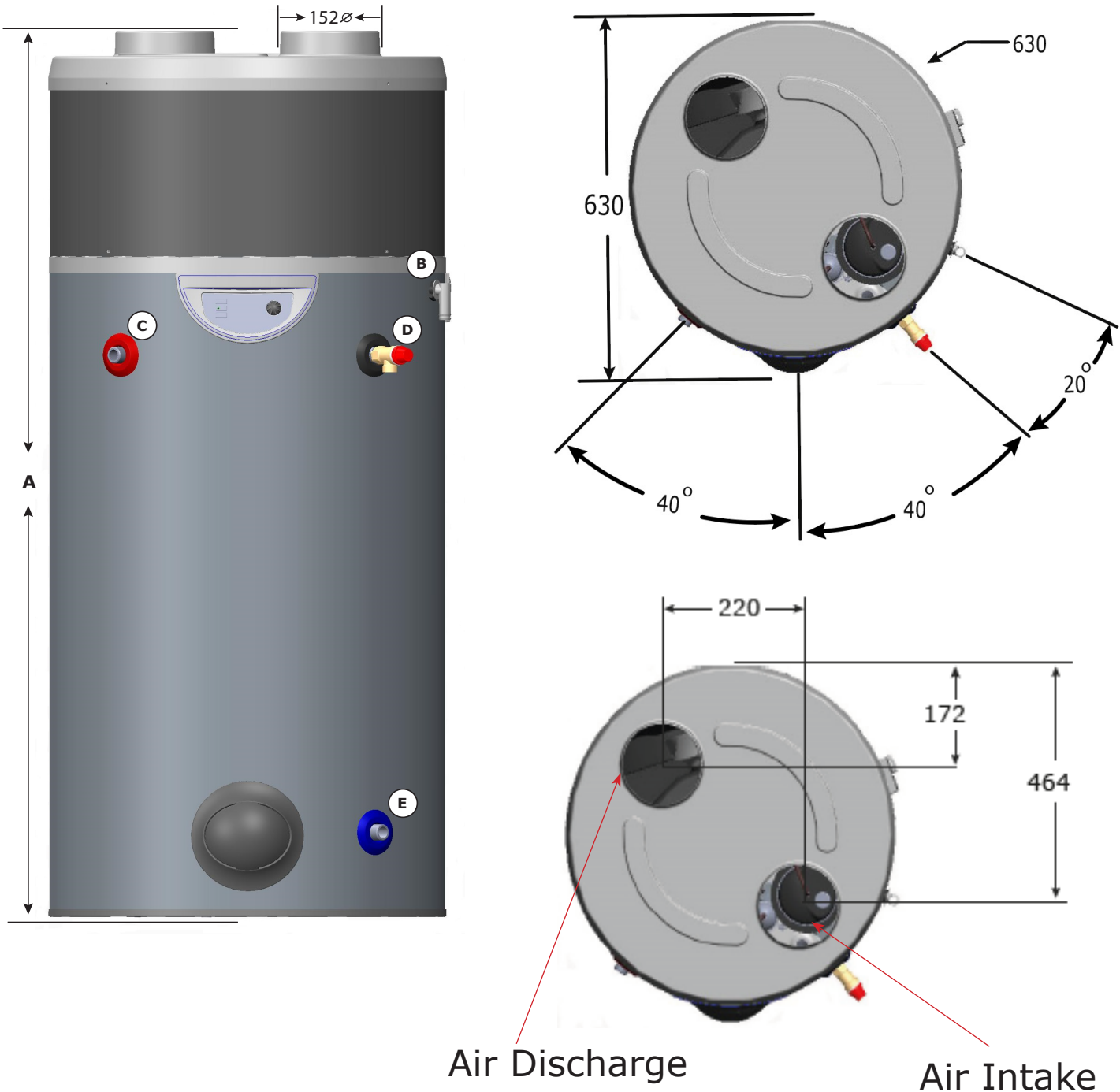

Figure 11: Edel Air Source Water Heater Dimensions (for reference only)

Edel Air Source Water Heater - Dimensions			
Reference		EDL200UK-630	EDL270UK-630
Capacity [l]		200	270
Hot Water Capacity [l]*		164.12	228.65
Weight - Empty [kg]		56.5	63
Weight - Full [kg]		254	332
Heat Up Time [hh:mm]*		07:15	09:48
Heat Loss [kWh/24h]		1.61	1.77
Height [mm]	A	1460	1780
Outer Diameter [mm]		630	630
Condensates Pipe [mm]	B	1025	1310
Hot Water Outlet [mm]	C	900	1245
T&P Valve [mm]	D	900	1245
Cold Water Inlet [mm]	E	155	155

Table 8: Edel Air Source Water Heater Product Dimensions

GDC Group Ltd		Edel Air Source Water Heater - Product Fiche	
Reference		EDL200UK-630	EDL270UK-630
Load Profile - Primary		M	L
Energy Rating		A+	A+
COP		3.36	3.30
Thermostat Setting		55°C	55°C
Sound Pressure level at 2m [dB(A)]		37(Speed 1)/40(Speed 2)	
Average Climatic Conditions			
Average Energy Consumption [kWh]		377	746
Water Heating Efficiency [%]		136	138
Daily Electricity Consumption [kWh]		1.84	3.53
Warmer Climatic Conditions			
Annual Energy Consumption [kWh]		351	617
Water Heating Efficiency [%]		136	166
Daily Electricity Consumption [kWh]		1.84	2.93
Cooler Climatic Conditions			
Annual Energy Consumption [kWh]		351	805
Water Heating Efficiency [%]		113	113
Daily Electricity Consumption [kWh]		2.21	3.8

Table 9: Edel Air Source Water Heater Product Fiche

*Cylinder is tested in accordance with EN12897:2006

Edel Air Source Water Heater - Product Features	
Materials	
Inner cylinder	Stainless steel
Outer cylinder	Plastic
Inlet/outlet	Stainless steel
Insulation	50mm PU foam (GWP=1, ODP=0)
Maximum Operating Conditions	
Potable water temperature	65°C
Operating pressure	3 bar
Maximum design pressure	6 bar
Heat Pump max. pressure	25 bar
Cold Water Supply	
Minimum dynamic pressure	1.5 bar
Maximum pressure	12 bar
Minimum flow rate	15 l/min
Connections	
Cold water inlet	M 3/4" stainless steel
Hot water outlet	M 3/4" stainless steel
Air pipe diameter (inlet and outlet)	160 mm
Immersion Heater	
1 ¼ M BSP 1.2 kW@240V	
Ventilation	
Air flow rate	320 m³/h
Air temperature	-7°C to 35°C
Max. air pipe length	rigid piping: 20m in total (intake and rejection)
Condensates flow rate	0.3 L/h
Condensates drainage pipe	18/24 mm
Safety Components	
Pressure reducing valve and strainer	3 bar
Expansion relief valve	6 bar
Temperature and pressure relief valve	7 bar/90°C 1/2" BSP
Factory pressure test	12 bar
Integrated electrical back-up power	1200W (safety setting = 85°C)
Approvals	
KIWA approval number - 1701712	
Guarantee	
Inner cylinder	5 years
Immersion heaters	2 years - excluding the effects of lime scale or other water borne contaminants
Other components	2 years - excluding expansion vessel membrane pressure

Table 10: Edel Air Source Water Heater Product Features

Air Intake

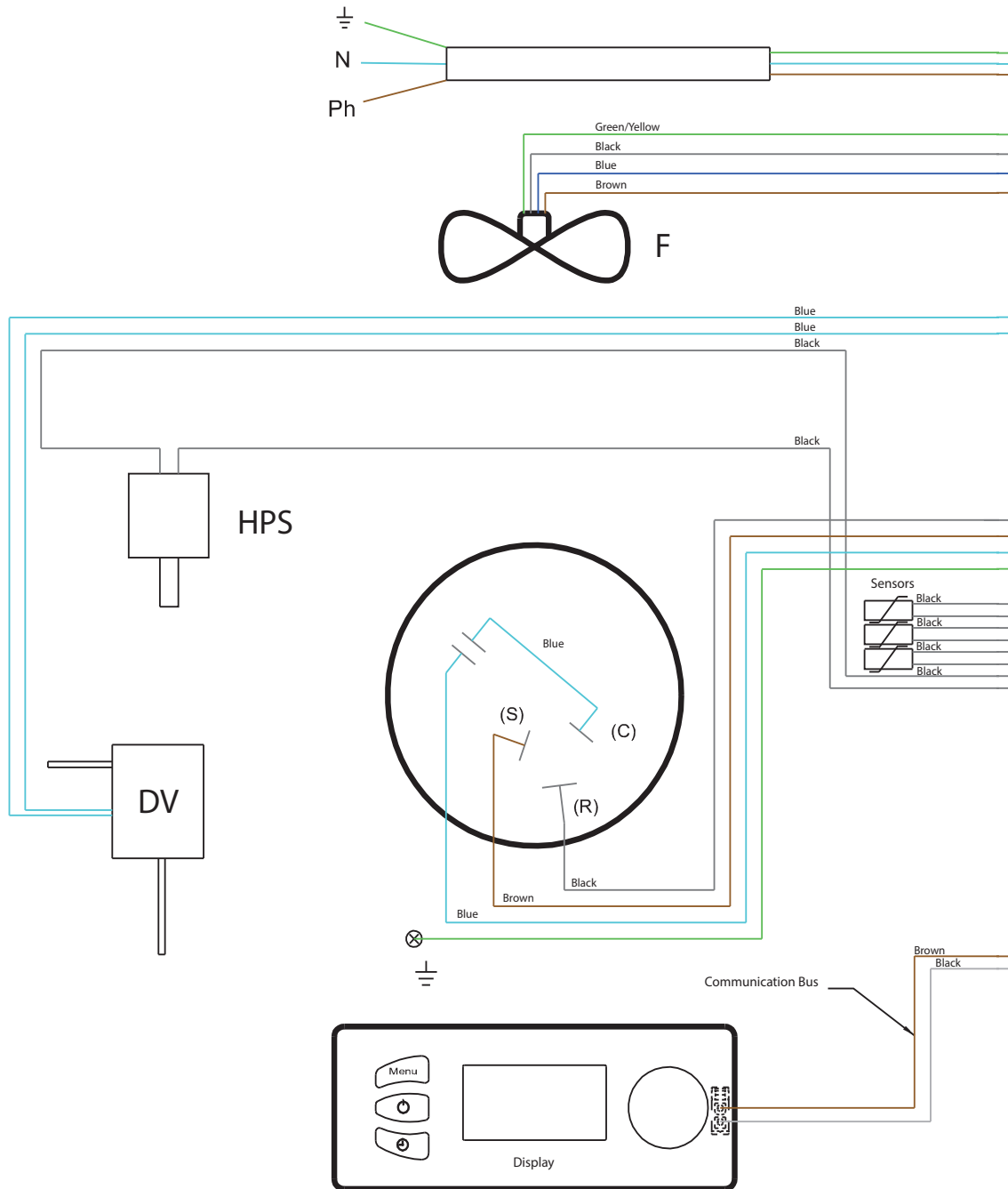

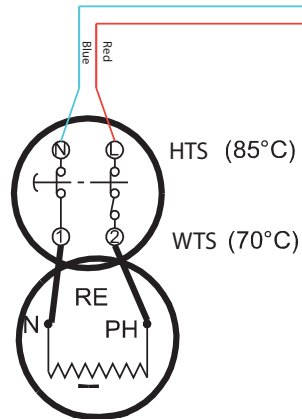
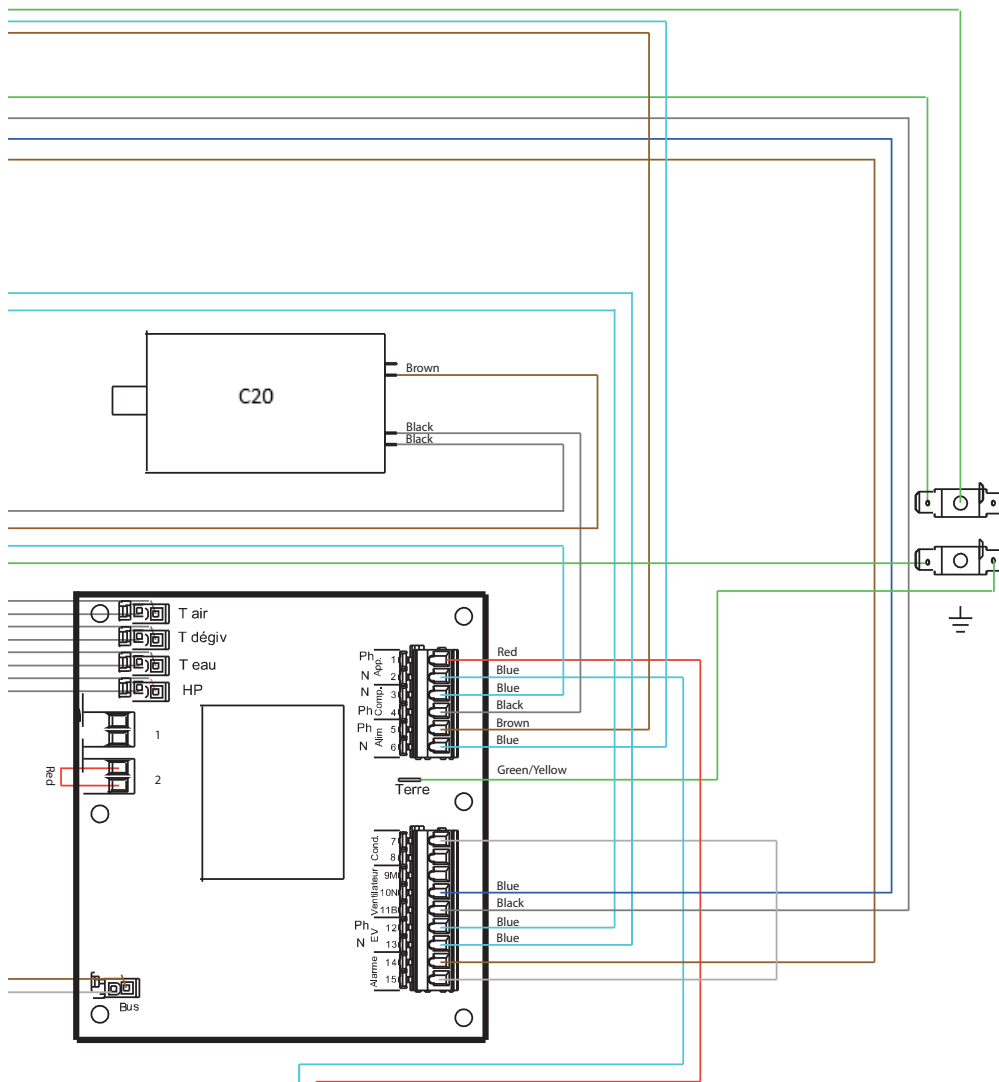

- HPS - High Pressure Switch
- C25 - Compressor Start Capacitor
- C2 - Fan Capacitor
- C4 - Valve
- F - Fan
- DV - Defrost Valve
- RE - Immersion Heater
- LTS - Immersion Heater Safety Cut-out
- WTS - Immersion Heater Water Temp. Stat

SERVICE RECORD

It is recommended that your hot water system is serviced regularly and that the appropriate Service Record is completed.

Service Provider

Before completing the appropriate Service Record below, please ensure you have carried out the service as described in the manufacturer's instructions.

SERVICE 1 Date _____
Engineer Name _____
Company Name _____
Telephone Number _____
Comments _____

Signature _____

SERVICE 2 Date _____
Engineer Name _____
Company Name _____
Telephone Number _____
Comments _____

Signature _____

SERVICE 3 Date _____
Engineer Name _____
Company Name _____
Telephone Number _____
Comments _____

Signature _____

SERVICE 4 Date _____
Engineer Name _____
Company Name _____
Telephone Number _____
Comments _____

Signature _____

SERVICE 5 Date _____
Engineer Name _____
Company Name _____
Telephone Number _____
Comments _____

Signature _____

SERVICE 6 Date _____
Engineer Name _____
Company Name _____
Telephone Number _____
Comments _____

Signature _____

SERVICE 7 Date _____
Engineer Name _____
Company Name _____
Telephone Number _____
Comments _____

Signature _____

SERVICE 8 Date _____
Engineer Name _____
Company Name _____
Telephone Number _____
Comments _____

Signature _____

SERVICE 9 Date _____
Engineer Name _____
Company Name _____
Telephone Number _____
Comments _____

Signature _____

SERVICE 10 Date _____
Engineer Name _____
Company Name _____
Telephone Number _____
Comments _____

Signature _____

Disregarding the instructions given in this manual in its entirety and any relevant regulations, standards and codes of practice will void the guarantee of this product. Glen Dimplex reserve the right to revise products, literature and guarantee terms without prior notice due to a policy of continuous improvement.

To speak to customer services please contact:

Glen Dimplex UK LTD.

Millbrook House Grange Drive, Hedge End,
Southampton SO30 2DF

Telephone: +44 [0]344 879 3588

Fax: 0844 879 3583

Email: customer.services@glendimplex.com



www.KIWA.co.uk



www.HWA.co.uk

