



Filterless Extract Fan SELV

INSTALLATION GUIDE FOR ENGINEER / INSTALLER



IPX5

Thank you for choosing EnviroVent

The fastest growing ventilation company in the UK.

You are about to install a product that is designed to outlast the life-cycle of the building. Once installed the unit will operate continuously for 5 years and beyond without a major service. Please therefore ensure that this product is treated with care and installed properly i.e. for the life of the building. If the unit is mishandled you might break it! This invalidates the warranty.

And remember, if you have any problems please call our dedicated Technical Team. We are always pleased to help and in an emergency will come out to site quickly, completely free of charge.

Wiring the fan correctly..

- ① The connection into the fan **MUST** be a flexible cable and **NOT** solid core twin and earth, if the fan is mishandled or a solid core twin and earth cable is forced into the terminals you **WILL** break it, this will invalidate the warranty.

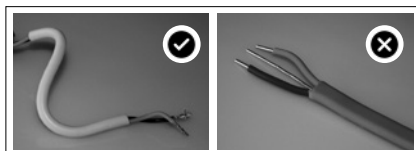

- ② If it is necessary to use twin and earth you must not take it into the fan. Use a terminal block to make the connection between the flexible cable supplied with the fan and your solid core twin and earth cable. 12V D.C - Red wire on fan must connect to red wire on SELV unit.

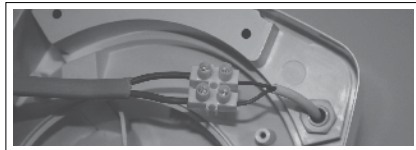

- ③ Place the cables inside the void in the back of the back carcass next to the cable gland and secure the fan to the wall securely.

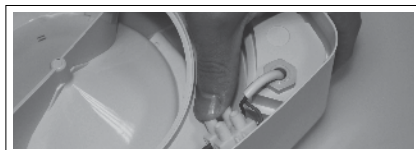

IMPORTANT: The black grommets and sticky pad provided must be fitted in this unit. Not using these items will jeopardise both the IP rating and the warranty.



Due to our policy of continuous innovation and improvement EnviroVent reserves the right to alter products specification and appearance without notice.

ABOUT THE UNIT

This fan is designed for easy cleaning and long life. Keep this user guide handy. The fan has been set by the installation engineer to suit your kitchen or bathroom application. Your EnviroVent Filterless Extract Fan has been designed to improve air quality and reduce humidity levels in kitchens and bathrooms to help resolve the condensation and mould problems which can effect dwellings in winter.

HOW IT WORKS

The EnviroVent Filterless Extract Fan works in a constant trickle mode to create background ventilation to maintain a healthy environment.

Vapour tracking

As standard the unit is fitted with vapour tracking (except for 2 speed models, see below). The fan senses the amount of moisture being created in the room which causes the fan to increase in speed to match the rising humidity and reduce in speed to match falling humidity. This intelligent function reduces your energy costs, wear and tear on the motor and ensures a long quiet life.

Pullcord

All units are fitted with a pullcord override for odour control (if remote see below). In the event that you wish to activate the fan to full power in conditions of low humidity simply pull on the pullcord and the fan will boost to maximum extraction rate.

OPTIONS

Remote control

Remote control override for odour control. In the event that you wish to activate the fan to full power in conditions of low humidity simply press the remote control boost switch and the fan will boost to the maximum extraction rate for 3 to 4 minutes before returning to the trickle extract rate.

2 Speed Version

The unit is also available in a two speed configuration, without vapour tracking. These units run at a constant trickle or at boost speed as required by the user.

Remote Switch Wire

The unit is available with a remote switch wire. On these units the boost switch may be located up to 3 meters away from the unit.



ENERGY USE

Your EnviroVent Filterless Extract Fan uses the lowest possible energy. To be used as a guide only*.

- On background trickle ventilation the unit will use approximately 2 watts of energy - 50 times less electricity than a 100W light bulb = £2.41 per year.
- On bathroom boost mode for 2 hours and trickle mode for 22 hours per day the unit will use approximately 7 watts of energy = £3.18 per year.

Remember! The above low running costs can be reduced on humidity tracking.

*Electricity suppliers have different rates - All costs are based on an electricity cost of £0.15 per unit (kWh) as of September 08.

INSTALLATION INSTRUCTIONS



IMPORTANT

Be sure to have read and understood these instructions before beginning the installation process.

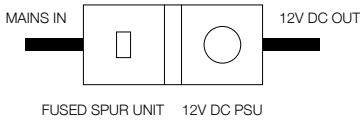

This fan operates on 12 Volts D.C.

DO NOT CONNECT TO MAINS, the fan must be connected to the SELV (12V D.C) power supply/ spur unit enclosed

Please note that an unswitched fuse spur is used on the power supply unit. This does not affect the performance of the unit.

SAFETY AND RECOMMENDATIONS

All wiring must comply with Building Regulations and the current IEE Wiring Regulations 17th edition (BS7671) or the equivalent standards for your country. The final installation should be examined and tested by a qualified electrician.

DO NOT WIRE THROUGH A LIGHT SWITCH

- This is a constant trickle fan which requires permanent electrical supply.

DO NOT REMOVE OR TAMPER WITH ELECTRONIC CIRCUIT BOARD

- This is not a user function.

FILTERLESS EXTRACT COMPONENTS

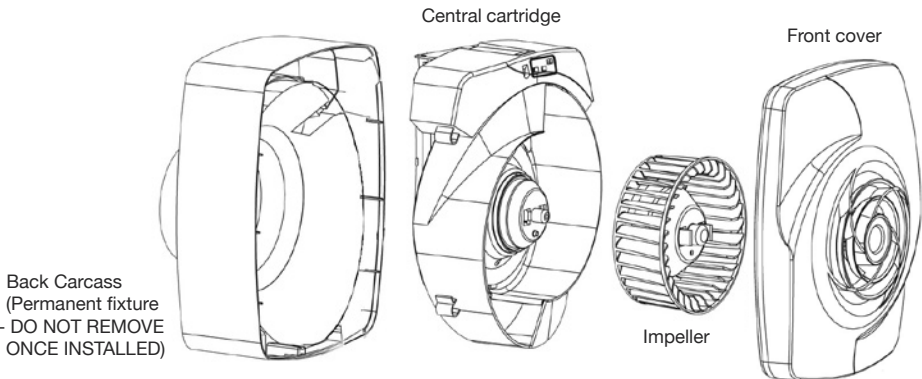

Back Carcass
(Permanent fixture
- DO NOT REMOVE
ONCE INSTALLED)

Central cartridge

Front cover

Impeller

SHOULD YOU ENCOUNTER ANY PROBLEMS INSTALLING THIS UNIT CALL

☎ 07540 050 147

INSTALLATION INSTRUCTIONS

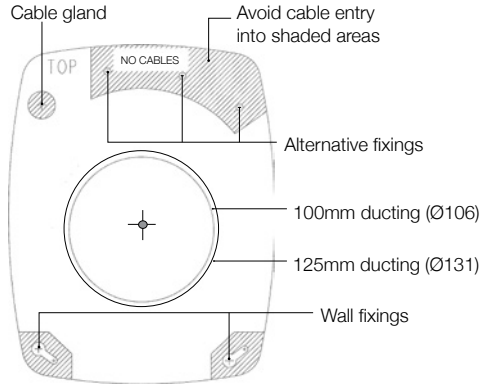

NOT TO SCALE - FOR GENERAL INFORMATION ONLY

1. Loosen the two plastic screws and remove front cover. (Fig 1.)
2. Carefully withdraw central cartridge from the carcass. Disconnect green male/female connector (Fig.2).
3. Drill a 107mm hole in chosen position ensuring clearance around the fan. Insert ducting to suit (not supplied).
4. Use the back carcass as a template - mark fixing holes - drill, plug and screw the back carcass into the wall with the screws provided. Fit the 3 blanking plugs into holes in top chamber.
5. This fan must be installed by a competent person. Complete electrical wiring of fan and tighten cable gland. Low voltage requires connection via power supply provided. Ensure red to red and check mains connection in fuse spur.
6. Offer up the central cartridge, join male/female connector (12V DC) and carefully insert the central cartridge into back carcass.
7. Insert four silver screws to fix central cartridge in place. N.B. Take care not to trap cables.
8. This fan is factory set to bathroom duty with humidity tracking function. If two speed, commission the fan by setting the slider switch as appropriate. Fix supplied gasket over selector switches (Fig.3).
9. Check that the impeller is fitted correctly ensure 'click' action engaged cleanly.

10. Fix front cover (Fig.1). Ensure that the pullcord nestles into groove. N.B. Fan will not operate unless front cover is in position.



Fig.1

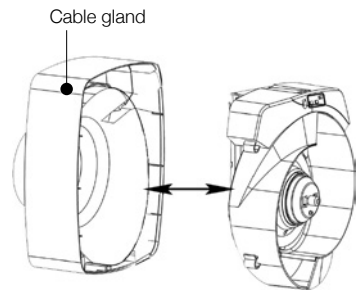

Fig.2

Back carcass Central carcass

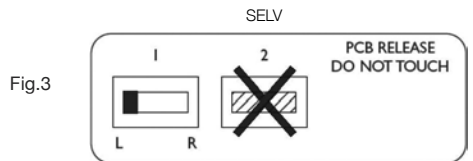
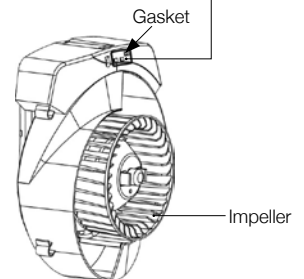

Fig.3

- NO KITCHEN OPTION
- ① LEFT - HUMIDITY TRACKING
RIGHT - TWO SPEED
 - ② SLIDER NOT IN USE



SHOULD YOU ENCOUNTER ANY PROBLEMS INSTALLING THIS UNIT CALL

☎ 07540 050 147

MAINTENANCE

All repair, maintenance and component replacement is carried out simply and quickly by exchanging the plug out/plug in central cartridge.

The worn out cartridge can then be returned to the EnviroVent factory to be recycled/reworked.

This 'when necessary' cartridge exchange – with re-worked components will ensure that the basic fan installation will remain intact throughout the repair cycle of the dwelling, eliminating the wasteful disposal of plastic and other non biodegradable material to landfill sites.

CLEANING

Your Filterless Extract Fan has been designed for easy safe cleaning.

ISOLATE THE UNIT FROM ELECTRICAL MAINS SUPPLY BEFORE REMOVING ANY COVER, OR SERVICING THE UNIT.

1. Isolate from mains.
2. Remove front cover. (Fig.1)
3. Pull the front cover towards you from the bottom. It will pull towards you with a slight hinge action from the top.
4. Push the impeller clips together with forefinger and thumb and pull the impeller towards you. (Fig.2)
5. Wash the cover and impeller in warm soapy water. Dry and replace as above in reverse. (Fig.3)
6. N.B. Use damp, soapy cloth to clean scroll (NO solvents).

Fig.1

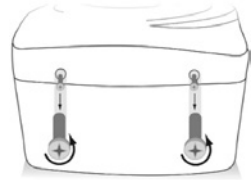

Fig.2

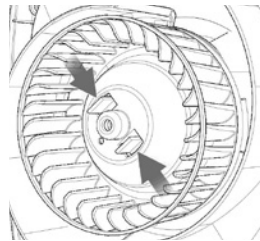
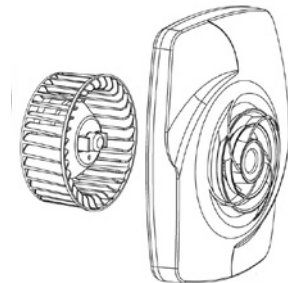

Fig.3



TROUBLESHOOTING

- Check feed/power supply
- Have you checked connections (green male/female connector)?
- Have you removed printed circuit board for any reason?
- Is the cartridge correctly seated (no stray wires trapped)?
- Does the impeller spin freely (check click)?
- Is the front cover in place?
- Does the pullcord activate freely?
- If you still experience difficulties then please call our hotline on 07540 050 147

AFTER SALES SERVICE

We recommend that you do not dismantle or remove any other parts than those mentioned, as any tampering would automatically cancel the guarantee. If you detect any fault, please contact EnviroVent on 01423 810 810.

OTHER APPLICATIONS/VARIATIONS

For recessed only installations we can supply a bezel.

Gold Standard After Sales Service

In the unlikely event of any on-site installation problems or queries regarding the EnviroVent Filterless Extract Fan, just call our hotline number. We will take your details and appoint a regional installation manager to call you back to discuss the problem. In the majority of cases, the problem can be resolved over the phone. However, in cases where the problem cannot be resolved over the phone, we will arrange a visit from our Gold Standard Engineer. He will meet with your contractor/direct labour on-site to discuss and resolve the problem, he will also provide training and give advice on the installation of the fan.

Installer Hotline: 07540 050 147

TECHNICAL SPECIFICATIONS

Duty (l/s)	Power (W)	Sound dB(A) @ 3M
15	2	30.8
35	7	36
60	25	46.2

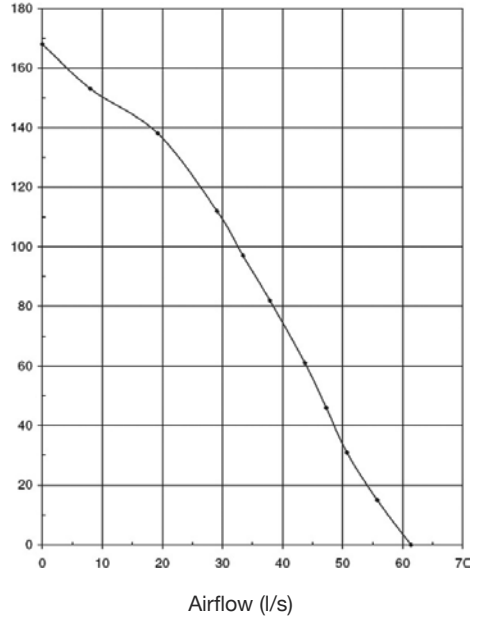

OPTIONS & ANCILLARIES

Description	Code(s)
Remote Pullcord	EFHTCM-RC
Remote Wall Switch	EFHTCM-WS
Wall Mounted Kit	1RD EFWAK
Ceiling Mounted Kit	1AC EFCMBR
Window Fixing Kit (230V)	EFWIK230V
Window Fixing Kit (SELV)	EFWIK12V
In-line Fixing Kit	EFIL-WIK

SHOULD YOU ENCOUNTER ANY PROBLEMS INSTALLING THIS UNIT CALL

☎ 07540 050 147

WARRANTY CONDITIONS AND EXCLUSIONS

The EnviroVent Filterless Extract Fan is covered by a full 5 year warranty which will benefit the occupier over many years. The unit will be set according to the size of the property and will operate continuously. There is no requirement for any maintenance within the 5 year period.

What should I do if I have a problem?

If, after thoroughly reading this booklet, you feel that your Filterless Extract Fan unit is not working correctly, you can telephone 07540 050 147 (operational from 8:00am to 5:00pm Monday to Friday), and ask for technical assistance. You will either be given guidance over the telephone, or an arrangement will be made for an engineer to visit. In any event, please have the following information ready. This will enable your call to be dealt with quickly and efficiently.

Please note that proof of purchase by the way of a receipt is required and that any fans bought from an unapproved source, including but not limited to Ebay, will render the guarantee invalid.

Serial number of the unit.....

We appreciate you choosing this quality EnviroVent product, which is designed and manufactured to the highest specification in Harrogate, North Yorkshire. We are confident that you will be delighted with the performance of the system and the resulting improvement in air quality in your home after the installation of the unit.

Your warranty covers any defect or break down that arises due to faulty materials or construction.

Terms of Warranty

- The system must be correctly installed and operated according to the instructions contained in the user guide supplied.
- The warranty will be rendered invalid if the system has been serviced, maintained, repaired, taken apart or tampered with by any person not authorised by EnviroVent Ltd.
- The warranty will be rendered invalid if the unit is turned off. Turning the unit off can damage it.
- The warranty does not cover accidental damage, misuse or abuse.
- The warranty is in addition to your statutory or legal rights.
- The guarantee will only be honoured from approved suppliers.



Delivering innovative and sustainable
ventilation solutions worldwide



 Please read carefully to ensure simple installation and a long trouble free life for the user.

AFTER INSTALLING THIS FAN PLEASE PASS ONTO END USER - DO NOT THROW AWAY

EnviroVent Ltd
EnviroVent House
Hornbeam Business Park
Harrogate
HG2 8PA

T 01423 810 810
F 01423 810 910
E info@envirovent.com

www.envirovent.com

E&OE | MKT ENV213-V6-27.03.14

Due to our policy of continuous innovation and improvement EnviroVent reserves the right to alter products specification and appearance without notice.