

JC080104







Skytile TP(a) UGR

Skytile 600x600mm 30W IP44 4000K 3000lm Tp(a) UGR <19



Features & Benefits

- Meets TP(a) requirements, suitable for all applications
- UGR <19 as standard, designed to comply with BS EN 12464-1 lighting of workspace
- Ultra efficient 100LpcW
- DALI/1-10V and DSI Dimming versions available
- IP44 protection against dust and moisture
- Comes with non-dimmable flicker free driver as standard
- Suspension kits and surface mount boxes available
- Suitable for use with JCEM002 and JCEM002ST emergency remote packs
- This product contains a light source of energy efficiency class F

					
WARRANTY	CRI:RA	BEAM	CLASS II	<19	RATING

General Information

Mounting	Recessed
Trade Name	Skytile
Environment	Indoor
Suitable For Zones	Outside zone 1
Product Group	LED - Recessed
Color Finish	White
Product Shape	Square
Product Range	Skytile
Overall Dimensions	597 x 595 x 9.8 mm
Length (mm)	595
Width (mm)	595
Height (mm)	9.8
Product Weight(kg)	2.3
Light Source	LED
Light Source Features	Neutral White
Additional Information	Not fire rated
Luminaire Accessories	Skytile surface mount tray(JC71262) Suspension kit (JC71311)
Recommended Product Location	indoor use only, T grid ceiling systems

Minimum Void Requirement	150mm
Method Of Fix	sits in 15mm and 25mm ceiling grid system
Distance From Lighted Object	0.3m
IP Rating	IP44
Origin of manufacturer	Made in China
Warranty	4 years standard warranty extends to 5 years when registered within the first year of purchase (inc 2 year on site)(See Website for terms and conditions)
Suspension Kit Safe Working Load	20kg
Driver Manufacturer	Ledtu
LED Manufacturer/Type	Runlite 4014
Lighting Product Type 1	Troffer

Electrical

Voltage Rating	220-240
Primary Running Current(Amp)	0.2
Inrush current(Amps)	<15
Operating Frequency Hz	50/60Hz
Secondary running current(mA)	700
Constant Current or Constant Voltage	CC
Luminaire Circuit Wattage	30
Class	II
Output Voltage Max/Range (VDC)	27-45
Total Harmonic Distortion (THD)%	20
EMC Compliant (EN55015)	Yes
Power Factor Correction	0.9
Input Electrical Connections	Live(brown)Neutral(blue)
Dimmable	No

Thermals

Thermal Cut Out	yes, auto recovery
Insulation Coverage	do not cover
Minimum Free Air Space	100mm above and 50mm to sides
Minimum Void Requirement	150mm
Operating Temperature Range °C	-25 to +45

Performance Data

LED Life (Hours)	54000
------------------	--------------

Hours life stated is an indication of expected L70 chip and light output calculations when operating in optimum conditions. Product warranty period supports the full product during the term given. The L70 hours expectancy is not correlated with the full product warranty term, nor is it a representation of lumen depreciation during the warranty period.

Energy Rating	This product contains a light source of energy efficiency class F
Actual Lumen Output	3000
Lumens Per Circuit Watt	100 LpcW

Standard Deviation Colour Matching - SDCM	<6
Color Rendering Index	80-89
CRI: Ra	80
Correlated Color Temperature	4000K
Beam Angle °	90
LOR (Light Output Ratio) %	100
Photometry Available	Yes

Controls and Sensors

Overload Protection	Yes
---------------------	-----

Construction

Primary Material	Aluminium
Inner Diffuser	Methylmethacrylate-Styrene (MS)
Outer Diffuser	Polystyrene (PS)
Heat Sink	Aluminium
Driver Housing	Polycarbonate

Packaging

Quantity Per Outer Carton	5
Outer carton(L)- cm	67
Outer carton(W)- cm	22.5
Outer carton(H)- cm	71
Outer carton Net weight- kg	12.5
Outer carton Gross weight- kg	13.5
Product Bar Code EAN-13 Number	5052544116582
Outer carton Bar Code ITF-14 Number	15052544116589

Standards & Approvals

Manufactured In Accordance To	BS EN 60598-2-2
CE Marked	Yes
UKCA Marked	Yes
Date code/Purchase order No.	Yes
WEEE Symbol	Yes
Certificate Of Conformity	Available on request
Accredited Members	LIA, ISO9001-2015, ISO14001-2015

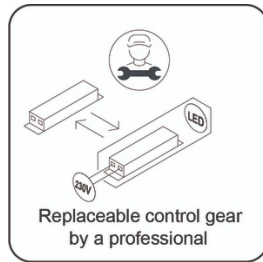
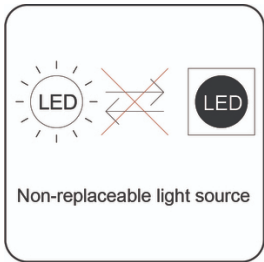
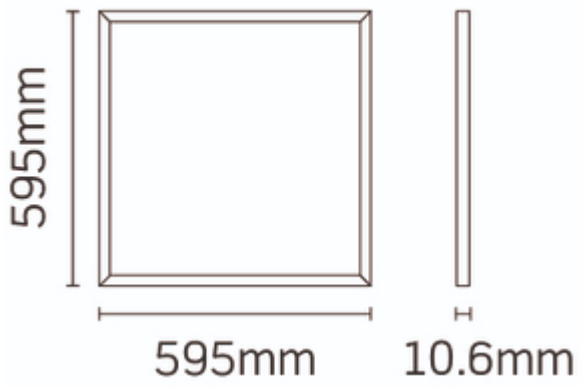

JCC Lighting LTD, Lux Park, Chichester Business Park, City Fields Way, Tangmere, Chichester, West Sussex, PO20 2FT.
Sales: 01243 838999 (8am to 5pm Monday to Friday) Fax: 01243 838998 | sales@jcc.co.uk | www.jcc.co.uk
Company Registration Number: 03044848 | VAT Number: 918544112

This document is uncontrolled if printed, all information is subject to change

Version 122 [24/03/2023]