

Rointe

D SERIES Digital radiator with Wi-Fi / Radiador digital con Wi-Fi / Radiador digital com Wi-Fi / Digitale radiator met Wi-Fi

EN **INSTALLATION AND USER MANUAL**
Page 02

ES **MANUAL DE INSTALACIÓN Y USO**
Página 26

PT **MANUAL DE INSTALAÇÃO E DE UTILIZAÇÃO**
Página 52

NL **INSTALLATIE- EN GEBRUIKERSHANDLEIDING**
Page 77

GUARANTEE / GARANTÍA
/ GARANTIA / GARANTIE

10

YEARS / AÑOS
/ ANOS / JAAR

3

YEARS / AÑOS
/ ANOS / JAAR

ON THE BODY
EN EL CUERPO
NO CORPO
IN HET LICHAAM

ON ELECTRONICS
EN ELECTRÓNICA
NA ELECTRÓNICA
IN ELEKTRONICA

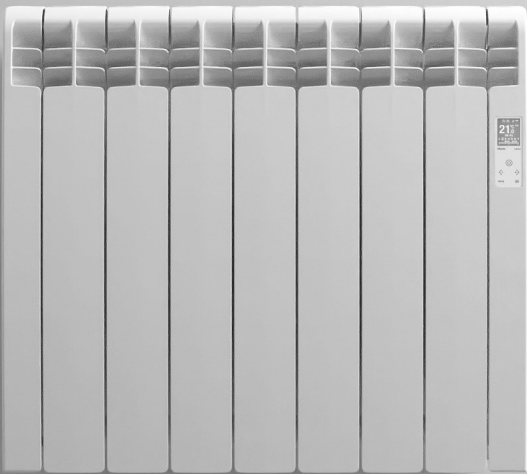

SYMBOLS



DANGER. This symbol indicates a medium-high risk hazard which can result in serious injury or even death.



DO NOT COVER. Do not dry or leave clothes or towels on the radiator. Do not leave or place magazines, spray cans, volatile substances, or similar objects within 250 mm of the radiator.



HOT SURFACE. This symbol indicates that your surfaces are hot during and immediately after use. These must not be touched: danger of burns.



OBSERVE THE INSTRUCTIONS IN THE MANUAL. Please read this manual carefully before installing and using the product. Keep it for later use. Read all instructions and safety warnings. Failure to follow these can result in electric shock, fire or serious injuries.

INDEX

1. General Warnings	4
2. Technical information	7
3. Installation	8
4. Screen & Keypad	11
5. Functionality and programming	12
5.1. ON / OFF (stand-by)	12
5.2. Adjust the day and time.....	12
5.3. Adjust the temperature	13
5.4. Lock the control panel.....	13
5.5. Main menu	14
5.6. Main menu: Submenu settings	14
5.7. Main Menu: Energy sub-menu	15
5.8. Main menu: Equilibrium / Balance sub-menu	17
5.9. Main menu: Program sub-menu	17
5.9.1. Manual/Automatic functions.....	18
5.9.2. Programming options.....	18
5.9.3. User mode.....	20
5.9.4. Pilot wire function	22
5.9.5. Fuzzy Logic Control technology.....	22
6. Wi-Fi Pairing	22
7. Maintenance and cleaning	23
8. European Regulation (WEEE) 2012/19/EU	23
9. Guarantee	23
10. How to register your product guarantee	26
Directive ERP Commission Regulation	102
EU Declaration of Conformity	103

1. GENERAL WARNINGS** WARNINGS**

This product may be used by children over 8 years of age and by persons with reduced physical, sensory, or mental capabilities, or lack of experience and knowledge under strict supervision or instruction in the safe use of the product and if they understand the hazards involved. Children should not plug, adjust, clean, play with, or perform maintenance on this product. Children under 3 years of age should be kept away from this product unless supervised.

DO NOT use the product in enclosed spaces if the persons present cannot leave the room independently and are not under constant supervision.



DO NOT COVER. To avoid overheating, do not cover the radiator.

DO NOT place spray cans, volatile substances, or similar objects within 250mm of the product.

DO NOT use insecticides, paints, or chemicals on or near the product.



Some parts of this product could reach high temperatures and cause burns. DO NOT touch the external parts of the product when in operation.

DO NOT install near curtains or other flammable materials.

Particular attention should be paid when children and vulnerable people are present.

When using electrical appliances, precautions should be taken to reduce the risk of fire, electric shock and injury.

Never insert fingers, body parts or objects inside the product.

Make sure that the voltage indicated on the product's technical information corresponds to the voltage output you have at your socket.

Any repair or maintenance that requires the product to be opened the product must be carried out by personnel authorised by ROINTE, who must also be notified if a leak is observed. Only official spare parts approved by ROINTE should be used. Please observe the current and relevant regulations when disposing of this product and its thermal fluid.

If the power cable is damaged, it must be replaced by personnel authorised by ROINTE to prevent any damage.

To avoid the risk of suffocation, do not leave the packaging including bags and other items within reach of babies or children.

The product has an IP24 degree of protection and can be used in bathrooms, but not in the vicinity of bathtubs, taps, showers, water connections, toilets, swimming pools or other masses of water. The product must never be installed where it, the switches or the control panel are within the reach of people in the water. Never use the product with wet hands. Do not place any water containers (glasses, vases, etc.) on or near the product.

! IMPORTANT

- Disconnect the product from the power supply and make sure the product is at room temperature before any cleaning or maintenance. Do not use any abrasive substances on the product, such as (but not limited to) chemicals, coarse cloths, brushes, hard bristle, or wire/steel wool.
- To disconnect the product from the power source, remove the mains plug from the socket. Do not pull on the cable.
- ROINTE cannot be held responsible for incorrect sizing of the product unless it has been followed by an official ROINTE technical study.
- Before the first start-up, or before the start of winter, or when the product has not been used for many days, the appliance should be cleaned (follow the steps in the “maintenance” section of this manual).
- Do not sit or lean on the product.
- Temperature contrasts can generate “clicks” or noises in the device. This is not a fault of the product, but due to the expansion/contraction of the materials.
- When disposing of the product, the requirements set out in the legislation for the waste treatment and recycling must be followed. See WEEE in section 8.

2. TECHNICAL INFORMATION

MODELS	0330RAD	0550RAD	0770RAD	0990RAD	1210RAD	1430RAD	1600RAD
Number of elements	3	5	7	9	11	13	15
DIMENSIONS, WEIGHTS & FINISHES							
Width (mm)	350	510	670	830	990	1,150	1,310
Height (mm)	585	585	585	585	585	585	585
Depth (mm)	97	97	97	97	97	97	97
Installed depth (mm)	120	120	120	120	120	120	120
Weight (kg)	7,7	12,2	16,4	20,4	24,1	25,9	32,1
Finish	White RAL 9016 / Graphite / RAL color						
ELECTRICAL CHARACTERISTICS							
Nominal power (W)	330	550	770	990	1,210	1,430	1,600
Effective power (W)	125	209	293	376	460	543	608
Voltage (V)	230 ~V	230 ~V	230 ~V	230 ~V	230 ~V	230 ~V	230 ~V
Current (A)	1.5	2.4	3.4	4.3	5.3	6.2	7.0
SAFETY & INSTALLATION							
Safety thermostat	✓	✓	✓	✓	✓	✓	✓
Protection Grade	IP 24	IP 24	IP 24	IP 24	IP 24	IP 24	IP 24
Template & Installation Kit	✓	✓	✓	✓	✓	✓	✓
EAN	8436045913708	8436045913715	8436045913722	8436045913739	8436045913746	8436045913753	8436045913760
CODE	8436045913777	8436045913784	8436045913791	8436045913807	8436045913814	8436045913821	8436045913838

3. INSTALLATION

We recommend using a trusted Rointe supplier for installation of the product. Find the nearest one by calling us on **0203 321 5929** or using the locator on www.rointe.co.uk.

IMPORTANT: Prior to installation, please locate the metal tag located at the back of the product and note the product reference and serial number. You will need this information to register your guarantee. See section 10 for help on how to register the guarantee.

WARNING: Do not install the product directly over an electrical outlet or junction box. Do not install the product or use it outdoors. Do not install directly under a shelf. This product is designed to be installed on an interior wall using the ROINTE template, the installation kit and the fixings supplied. Do not install the product in such a way that it encounters the power cable.

The product must be mounted on the wall in the position shown in the accompanying image using the brackets and with the fixings supplied.

Our products transfer heat through the natural air convection. If the product is covered, this will disrupt the airflow and could cause overheating. It must be positioned in accordance with the minimum distances shown in the accompanying picture.

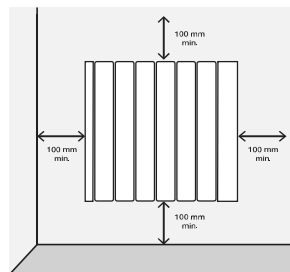

WARNING: The product has an IP24 degree of protection and can be used in bathrooms, but not in the vicinity of bathtubs, taps, showers, water connections, toilets, swimming pools or other masses of water. The product can only be installed in zone 3 of the accompanying picture. The product must never be installed where it, the switches or the control panel are within the reach of people in the water. Never use the product with wet hands. Do not place any water containers (glasses, vases, etc.) on or near the product.

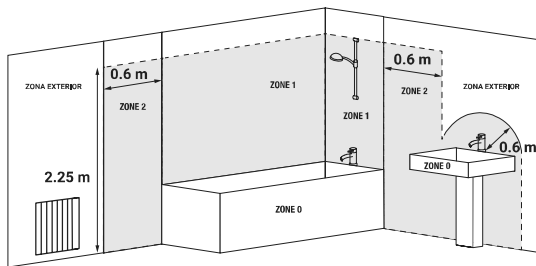

An installation kit is included in the product packaging. You will need a drill, a rubber mallet, a spirit level and a pencil to complete the installation.

WARNING: The weight of some of the products may be heavy. The installation may require two people.

IMPORTANT: Please follow these instructions carefully.

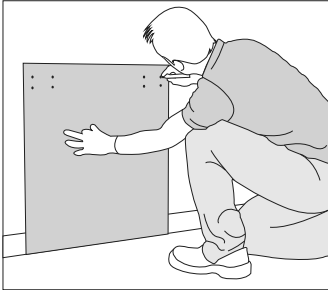

1. Remove the packaging and check that the installation contains brackets, screws, rawl plugs and a cardboard template.

2. Select a suitable location on the wall. Place the template on the wall and mark the holes for the brackets and screws. Observe the minimum distance requirements from the previous page.

Use the floor as a base for the template, not the skirting board.

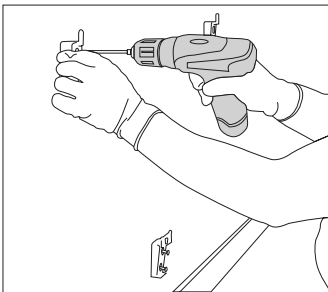

3. Remove the template and carefully drill out the marked holes.

4. Secure the upper brackets with the rawl plugs and screws provided. Then fix the lower bracket. **To distinguish it, the lower bracket has a different design from the top ones.**

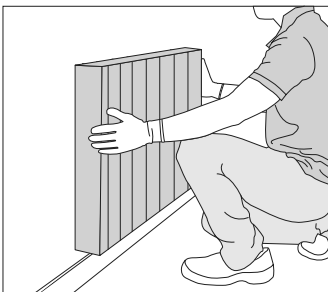
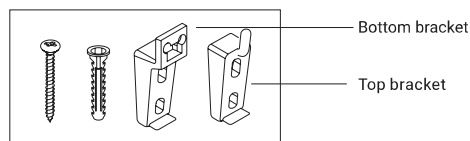

5. Slide the product up and down over the fixed brackets.

6. Check the straightness with a spirit level and adjust the supports accordingly if necessary.

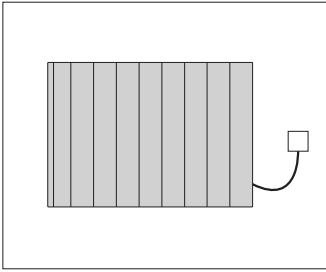

7. Connect your product to the power supply and switch it on.

8. See section 5 for operating instructions.

IMPORTANT: Measurement template per model.

0330RAD

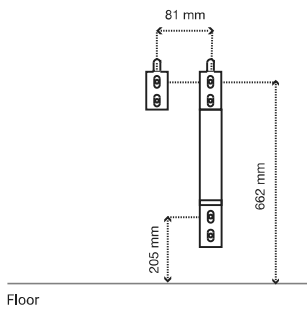

0550RAD

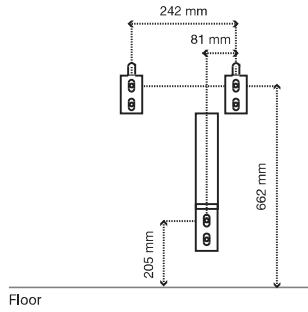

0770RAD

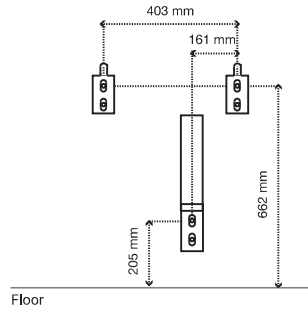

0990RAD

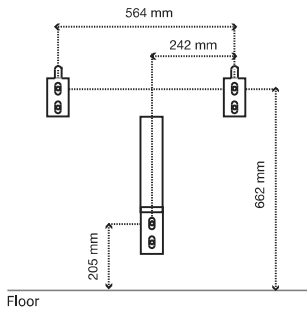

1210RAD

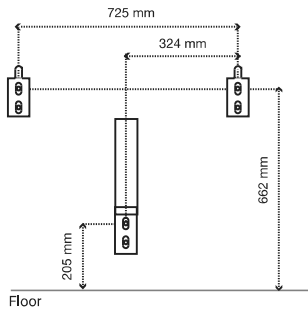

**1430RAD /
1600RAD**

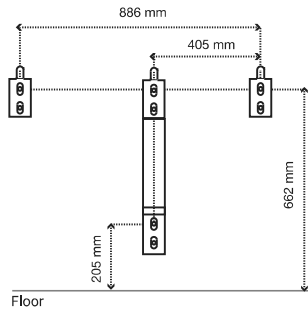

4. SCREEN & KEYPAD

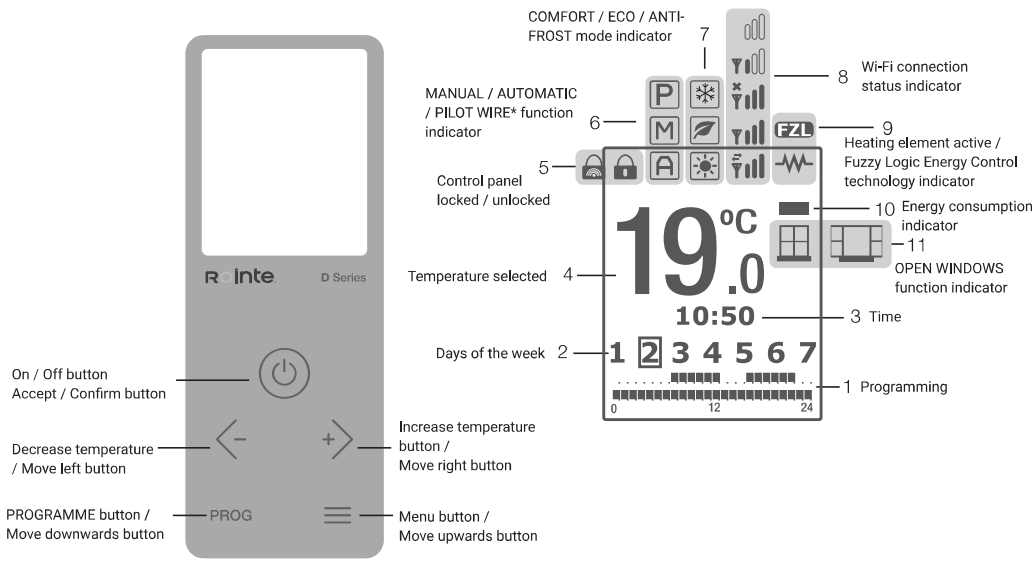





* PILOT WIRE function not available in UK. Only on demand.

SYMBOL	DESCRIPTION	SYMBOL	DESCRIPTION
	Heating element - active		MANUAL function - active
	OPEN WINDOWS function - DETECTED		PILOT WIRE function - active
	OPEN WINDOWS function - ACTIVE		AUTOMATIC function - active when USER mode active
	Energy consumption status - green / amber / red		MANUAL function - active when USER mode active
	Fuzzy Logic Control technology - active		PILOT WIRE function active* when USER mode active
	COMFORT mode - active		Connected to the server and router - sending and receiving.
	ECO mode - active		Connected to the server and router - maximum net signal.
	ANTI-FROST mode - active		Connected to the server and router - minimum net signal.
	Control panel locked through keypad		Connected to router. Not connected to the server.
	Control panel locked through remote		Not connected to the server or to the router.
	AUTOMATIC function - active	* PILOT WIRE function not available in UK. Only on demand.	



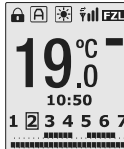







5. FUNCTIONALITY & PROGRAMMING



5.1. SWITCHING ON AND OFF (STAND-BY)

<p>To switch the product on, please press the  button on the keypad once.</p>	
<p>After 3 seconds the temperature, time and days of the week will show on the display panel.</p>	
<p>To switch the product off, please press the  button again once. The product will go into stand-by mode with the word 'STAND-BY' displayed on the display panel. After 3 seconds the Rointe logo will appear.</p>	

5.2. ADJUST THE DAY AND TIME

It is possible to change the radiator time from the control panel, but it is preferable to wait for automatic synchronisation once it is paired with the Rointe Connect application and the product is connected to the E-life Technology servers.

<p>Pressing the  key, you can access the Main Menu. To move left press the  button and to move right press the  button. Once the  icon is highlighted on the display panel, press the  button to access.</p>	
<p>Now use the  and  buttons again to select the clock option  and press  to access.</p>	

Use the <- and +> buttons to set the hour and then press  to confirm. Then use the <- and +> buttons to set the minutes and press  to confirm. Finally, use the <- and +> buttons to set the day (1 = Monday, 2 = Tuesday etc.) and confirm by pressing the  button.





5.3. ADJUST THE TEMPERATURE

To change the temperature, please press the <- or +> button. To decrease the temperature press the <- button and to increase the temperature press the +> button.

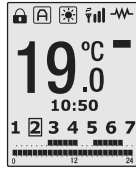
When the room temperature is lower than the set temperature on the display panel, the product will come on with the  symbol appearing in the top right of the display panel.



When the Fuzzy Logic Energy Control technology is activated the symbol  will replace the symbol  in the top right of the display panel.

To learn more about Fuzzy Logic Energy Control technology please see section 5.9.5.

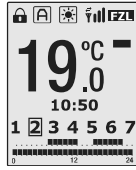

5.4. LOCK THE CONTROL PANEL

To lock the keypad manually, please hold and press the <- button AND the +> button TOGETHER for 3 seconds. The  symbol will appear on the display panel and the keys will not respond.



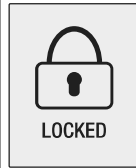

To unlock the keypad manually, please hold and press the <- button AND the +> button TOGETHER for 3 seconds.



When locking from the mobile application, the remote keypad lock icon will appear on the screen . When pressing any key on the product, the image on the right will be displayed on the screen. The remote keypad lock can only be unlocked from the mobile application.



5.5. MAIN MENU



The Main Menu is accessed by pressing the menu  button. You can navigate through the different options available on the menu by pressing the  and  buttons to move left and right respectively and to scroll through all 4 options. The selected sub-menu will be highlighted with a frame, as shown in the image to the right on the 'Settings'  section of the display panel.





The below icons displayed on the screen take you to the following sub-menus:

			
Settings	Energy	Equilibrium / Balance	Program

5.6. MAIN MENU: SETTINGS SUB-MENU

The 'Settings' sub-menu configures the technical parameters of your product. To access, select the  icon displayed in the Main Menu screen and press  to confirm.



Use the  and  buttons to move across the different options on the sub-menu to choose your parameter and press  to access.



The below icons displayed on the screen take you to the following parameters:



			
Display backlight brightness	Wi-Fi settings	Language	Time



• Adjust display backlight brightness

This allows you to change the brightness of the display panel in both the STAND-BY and ON modes separately. To change the brightness of the display panel ensure the  icon is highlighted and press the  button to confirm. Then with the  and PROG buttons you can switch between the two modes.

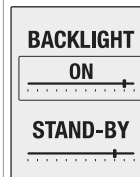
With the  and  buttons you can increase or decrease the brightness as you wish. The cursor indicates the intensity of the light. Once you have set the required brightness press the  button to save and exit.



• **Wi-Fi settings**



This option prepares the product to perform the PAIRING mode, creating its own network to which we will connect for the correct configuration of the product. Make sure that the icon  is flashing and confirm with .

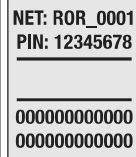

The next screen will show the data of the network created, the name of the Wi-Fi network (NET:) and the password (PIN:). Pressing the  button will exit the PAIRING mode, returning to the main screen.

Both to enter and exit the submenu you have to wait about 15 seconds. In addition, the product will restart.



• **Change the language**

To change the language of your product, ensure the  icon is highlighted in the 'Settings' sub-menu and press the  button to access.

Use the  and PROG buttons to move up or down respectively until your chosen language is highlighted and confirm by pressing the  button.











• **Adjust the day and time**

This option sets the hour, minutes and day of the week in your product. Please refer to section 5.2.





5.7. MAIN MENU: ENERGY SUB-MENU



The energy submenu gives access to the functions related to the energy management of the product. Select using the keys  and  the icon  of the main menu. Press  to access this screen. The following icons allow access to the different submenus:

				
OPEN WINDOWS function	Roimte Eye Detect function * Not available in UK. Only on demand*	Effective Power function	Information	



- **Open WINDOWS function**

<p>This option allows you to activate or deactivate the OPEN WINDOWS function. Use the and buttons  and PROG, to select ON to activate and OFF to deactivate. Once the desired option has been selected, press  to confirm and exit.</p>	<div style="border: 1px solid black; padding: 5px; text-align: center;"> <p>OPEN WINDOWS</p> <div style="border: 1px solid black; padding: 2px; margin: 2px 0;">ON</div> <div style="border: 1px solid black; padding: 2px; margin: 2px 0;">OFF</div> </div>
--	---







- **Rointe Eye Detect function**



<p>Allows you to enable or disable the Rointe Eye Detect function. Using the  and PROG buttons select ON to activate or OFF to disable. Once the desired option is selected press  to confirm and return to the main display.</p>	<div style="border: 1px solid black; padding: 5px; text-align: center;"> <p>EYE DETECT</p> <div style="border: 1px solid black; padding: 2px; margin: 2px 0;">ON</div> <div style="border: 1px solid black; padding: 2px; margin: 2px 0;">OFF</div> </div>
---	---

- **Effective Power function**

<p>To check the Power status of your product, make sure the icon  is flashing in the 'Energy' submenu and press the button  to access. This option shows on the display the actual consumption time of the product and the total time during which our product is connected to the mains. After a few seconds without pressing any button, the display will show the nominal power and the effective power of the product. The effective power corresponds to the average power value that our product actually consumes during operation.</p>	<div style="border: 1px solid black; padding: 5px; text-align: center;"> <p>WORKING TIME 000001h</p> <p>TOTAL TIME 000001h</p> </div>	<div style="border: 1px solid black; padding: 5px; text-align: center;"> <p>POWER(W) 1600</p> <p>EFFECTIVE POWER(W) 640</p> </div>
---	---	--

- **Information**





<p>This function will display the software version, the date of this release and the rated power of the product.</p> <p>To access this information, ensure the  icon is highlighted in the 'Energy' submenu and press the  button to confirm. The information will then show in the display panel. To exit press the  button or press the  button again to move onto the next display in the Information function.</p>	<div style="border: 1px solid black; padding: 5px; text-align: center;"> <p>SOFTWARE VERSION V1.00</p> <hr/> <p>19/02/2015 POWER 1100W</p> </div>
<p>Pressing , the screen displays the Wi-Fi connection status, connection type, IP address, subnet mask and gateway. To exit press the  or press  to return to the next screen in the information function.</p>	<div style="border: 1px solid black; padding: 5px; text-align: center;"> <p>WIFI STATUS dhcp:assigned IP, NM, GW: xxx.xxx.x.xxx xxx.xxx.xxx.x xxx.xxx.x.xxx</p> </div>

By pressing  we can know the MAC address and RSSI, signal strength which is measured in dbm. When this appears, if you press the power button once more, it gives you the option to update the firmware. If you press the same button again it will ask you "Wi-Fi?" and you will have to answer yes or no. It then restarts after a few seconds of waiting. To exit the information screen, press .

WIFI STATUS

MAC:
0:50:93
C4:03:F6
RSSI:-70

5.8. MAIN MENU: EQUILIBRIUM / BALANCE SUB-MENU

The balance submenu makes the product work in MANUAL function with a constant temperature of 19 °C. Access it by selecting the balance icon  using the keys  and . Confirm by pressing the key . Once pressed, the product returns to the main screen, with the temperature set at 19°C and the MANUAL function icon on.

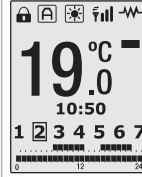

**5.9. MAIN MENU: PROGRAM SUB-MENU**





This section explains the operational aspects of your product in its various functions and modes.

What are the functions of MANUAL, AUTOMATIC and PILOT WIRE* functions?

MANUAL	This function allows you to change the product between the COMFORT, ECO and ANTI-FROST modes and to change the temperature (see section 5.3).
AUTOMATIC	This function will activate the programming that has previously been set in the product.
PILOT WIRE	This function allows the product to be controlled by a central programmer. * Not available in UK. Only on demand*

What are the COMFORT, ECO and ANTI-FROST modes?



 COMFORT	 ECO	 ANTI-FROST
From 19°C to 30°C	From 7.5°C to 18.5°C	7°C

The 'Program' sub-menu provides access to functions related to programming the product. To access, select the  icon displayed in the Main Menu screen, the buttons  and  and press  to confirm. The icons below provide access to the various submenus explained below:





MAN/AUTO		USER	PILOT
MANUAL / AUTOMATIC functions	Programming options	USER mode	PILOT WIRE function * Not available in UK. Only on demand.*

5.9.1. MANUAL / AUTOMATIC FUNCTIONS

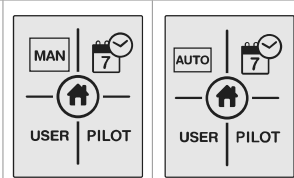



To change or choose the MANUAL or AUTOMATIC function, ensure the **MAN/AUTO** icon is highlighted in the 'Program' sub-menu and press the  button to confirm. You can change from AUTOMATIC to MANUAL and vice versa by pressing the  button again. The Automatic function activates the programming set in the product.

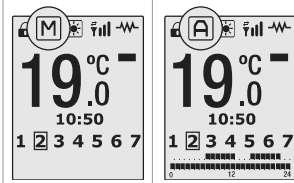

On the display panel, the symbol  will appear for the AUTOMATIC function and the symbol  for the MANUAL function.



5.9.2. PROGRAMMING OPTIONS



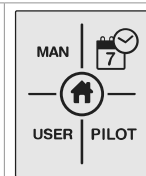

To start programming you must be in AUTOMATIC mode. Press the flashing icon  using the buttons  and  and confirm by pressing the button .



• Start programming for AUTOMATIC function



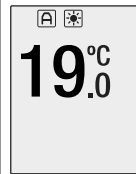

To program the AUTOMATIC mode, see points above and ensure that START PROGRAMMING is highlighted. Press the  button to access and the display panel will show a flashing screen.

STEP 1 - Select COMFORT mode temperature

 COMFORT mode will be programmed first. Select the COMFORT mode temperature between 19°C and 30°C using the  and  buttons. The  icon and the temperature will flash. Press the  button to confirm.





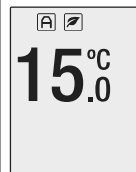

STEP 2 - Select ECO mode temperature

 ECO mode will be programmed next. Select the ECO mode temperature between 7.5°C and 18.5°C using the  and  buttons. The  icon and the temperature will flash. Press the  button to confirm.





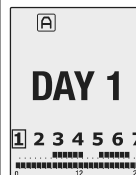

STEP 3 - Select the Days

The days of the week will start flashing on the display panel and show as DAY 1, DAY 2, DAY 3 etc.



Use the  and  buttons to move forwards or backwards through the days. Press  to select the day or days that you wish to include in your AUTOMATIC program. The day will stop flashing once selected. Repeat for all the days you wish to program and once all days are selected press the button  to move onto setting the hour.



STEP 4 - Select the Hours

Once step 3 has been completed, 0h appears on the display panel. 0h is equal to midnight. Use the  or  buttons to select the hour you wish to change. Use the  button to change the mode (COMFORT, ECO or nothing) for the hour you wish to modify. The corresponding icon for that mode will appear at the top of the screen. To finish the programming press  or leave for 30 seconds without pressing any buttons. To change the programming go back to step 1 and proceed as described before.

*If you wish to have individual days with different programming within your program you will need to modify each day separately, starting from the Main Menu again for each day/days. Follow Steps 1 to 4 above to program multiple differing days/hours/temperatures.

If you wish to activate the anti-frost mode in the hours that do not have COMFORT or ECO mode, from the main screen of the radiator and in automatic mode, press the key . If you want to reverse this action, press .

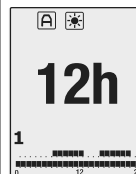

5.9.3. USER MODE

To enter the USER function, ensure the **USER** icon is highlighted in the 'Program' sub-menu and press the button to access. A 4-digit PIN code is required in order to access the menu. The default PIN is 0000.

To enter the PIN use the and and and **PROG** buttons to move left, right, up or down to select the correct numbers, pressing after each number is highlighted to confirm. Once the full 4 digits have been entered, move to **OK** on the display panel and press the button to confirm. Once the PIN number has been entered correctly, the main USER function sub-menu will be shown.

The below icons displayed on the screen take you to the following functions:

ENABLE / DISABLE functions	Change PIN	Upper temperature limit	Lower temperature limit

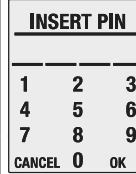

• **Enable / Disable functions**

To access the Enable/Disable function, ensure the icon is highlighted in the 'Program' sub-menu and press the button to access.



Use the and **PROG** buttons to move up and down respectively to select **ON** to enable or **OFF** to disable. Once the desired option is highlighted press the button to confirm. Use the button to go back to the main display panel or leave for 30 seconds without pressing any buttons.



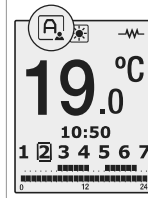
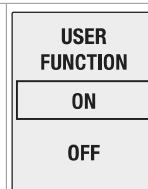

On the main screen you will see the icon in **AUTOMATIC** function, the icon in **MANUAL** function and when in **PILOT WIRE*** function.

PILOT WIRE function not available in UK. Only upon demand.



- **Change PIN code**

To change the PIN code of your product, ensure the  icon is highlighted in the 'Program' sub-menu and press the  button to confirm.

Use the  and  and  and  buttons to move left, right, up or down to select the new numbers, pressing  after each number is highlighted to confirm.

Then move to OK on the display panel and press the  button to confirm. The screen will show PIN CHANGED.



Please remember your new PIN code for the future and store in a safe place. In order to access the USER function menu again you will need your new PIN code.





NEW PIN		
1	2	3
4	5	6
7	8	9
CANCEL	0	OK



**PIN
CHANGED**



- **Upper temperature limit**





To set the upper temperature limit of your product ensure the  icon is highlighted in the 'Program' sub-menu and press the  button to access.

Use the  and  buttons to decrease or increase your desired upper temperature between 19°C to 30°C and press the  button to confirm. You will then return to the USER function screen. To exit press the  button to go back to the main display panel or leave for 30 seconds.

**UPPER
TEMPERATURE
LIMIT
22.0°C**

- **Lower temperature limit**



To set the lower temperature limit of your product ensure the  icon is highlighted in the 'Program' sub-menu and press the  button to access.

Use the  and  buttons to decrease or increase your desired lower working temperature between 7.5°C to 18.5°C and press the  button to confirm. You will then return to the USER function screen. To exit press the  button to go back to the main display panel or leave for 30 seconds without pressing any buttons..

**LOWER
TEMPERATURE
LIMIT
10.0°C**

5.9.4. PILOT WIRE FUNCTION

The PILOT WIRE function allows you to control your heating only via the pilot wire controller.

Activate or deactivate the pilot wire control function. Use the  and PROG, keys, select ON to activate and OFF to deactivate. Press  to confirm and exit. The main display will show .

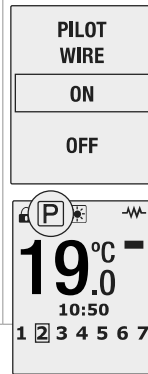

5.9.5. FUZZY LOGIC ENERGY CONTROL TECHNOLOGY

This product includes FUZZY LOGIC ENERGY CONTROL technology, which manages the product's energy consumption in the most efficient way. FUZZY LOGIC ENERGY CONTROL is a technology that bases its operation on the generation of thousands of micro cuts in the energy consumption of the heating element to keep the water temperature stable with minimum consumption.

When the symbol  replaces the symbol , then FUZZY LOGIC ENERGY CONTROL technology is in operation.

6. WI-FI PAIRING

To pair the device you must first create a zone in the application. Once inside this zone, press the icon  to start the pairing wizard. If you need more information, you can consult the complete installation manual from the following QR code:



7. MAINTENANCE AND CLEANING

The product does not require any maintenance. We recommend cleaning the product (back, bottom of the product, etc.). Do not use abrasive substances on the product, clean it with a damp cloth and neutral pH soap and the screen with a dry cloth. Before carrying out any cleaning operation, make sure that the product is switched off and at room temperature.

8. EUROPEAN REGULATION (WEEE) 2012/19/EU

Based on the European regulation 2012/19/EU on Waste Electrical and Electronic Equipment (WEEE), these appliances cannot be thrown in the usual council bins; they must be collected selectively to optimise the recovery and recycling of the components and materials that make them up, and reduce the impact on human health and the environment. The crossed-out wheeled bin symbol on a horizontal bar is marked on all ROINTE products to remind the consumer of the obligation to separate them for separate collection. The consumer should contact the local authority or the retailer for information regarding the correct disposal of their product.

9. GUARANTEE

1. Agreement

1.1. This section describes the guarantee conditions available to the buyer when purchasing a new product of the Rointe brand. These conditions include all the rights that the buyer has in accordance with current national legislation, as well as the guarantee and additional rights offered by the brand. Any incident detected in your Rointe product can be dealt with by the seller of the product or in a more agile way through the manufacturer itself.

1.2. Rointe offers you Technical Assistance from our After-Sales Service by telephone at +44 (0)203 321 5929 or email to support@rointe.co.uk, where we will indicate the steps to follow to solve the incident. You will need the product reference (located on the metal characteristics label), serial number, date of purchase and the nature of the fault when contacting us. In addition, you must have a copy of the proof of purchase of the product.

1.3. ROINTE guarantees there are no material defects of design or manufacture at the time of original purchase. ROINTE guarantees the body for 120 months (10 years) and the electrical plus electronic components for 36 months (3 years) for this product only, from the date of purchase, or delivery if later, provided it has not been modified, and in accordance with the provisions of the following stipulations.



2. Conditions

2.1. If during the guarantee period, the product under normal use, and with proper maintenance, fails to function properly and is found to be defective in design, material, or workmanship, it will be repaired or replaced at the customer's option, in accordance with the provisions of the law, and subject to the following terms and conditions:

2.1.1. The guarantee is only applicable if the original guarantee is issued by the seller and when such guarantee has been registered with Rointe correctly, including the product reference, serial number (marked on the metal label of the product), date of purchase and proof of purchase. The product guarantee can be registered on our website at www.rointe.co.uk or can be emailed to support@rointe.co.uk within 90 days of installation. ROINTE reserves the right to refuse a guarantee when this information has been removed or modified after the original product purchase.

2.1.2. The guarantee is only applicable if the product has been installed by a competent person in accordance with this installation manual and all regulations in force at the time of installation.

2.1.3. The guarantee is only applicable to those cases that refer to defects in material, design and manufacture, and in no case covers damage to the product for the following reasons:

- i) Damage caused by negligence and/or misuse of the product, i.e. used for purposes other than its normal use, or by not respecting the instructions for use, maintenance and cleaning given by ROINTE, as well as by incorrect or inadequate installation or use of the product that may not comply with the technical safety standards in force.
- ii) Corrosion of any part of the product caused by direct exposure to saltwater. Where the product is installed within 200 m of the coast, the guarantee period for damage caused by corrosion shall be reduced by 50%.
- iii) Any unauthorised modifications or repairs to the product carried out by third parties or unauthorised persons, or the opening of the product by third parties or unauthorised persons.
- iv) Any accident deemed to be beyond ROINTE's control, such as (but not limited to): lightning, fire, flood, natural disasters, public disorder, atmospheric or geological phenomena, and all those of a similar nature.
- v) Failures resulting from incorrect installation. In case of doubt, please contact ROINTE.

2.2. Any repair or replacement carried out as part of this guarantee service does not allow for extension periods or new guarantee periods, i.e. your guarantee will not be extended in the event that a repair or replacement of this product is carried out, but will be suspended until the product is returned repaired or a new one is delivered.

2.3. Any repair or replacement covered by this guarantee must be a functionally equivalent part. Defective parts or parts removed or replaced shall become the property of ROINTE and must be returned as such.

2.4. The product must be installed in such a way as to allow access by ROINTE technicians or authorised persons in the event that they need to access the product for repair or maintenance. The user/customer is responsible for the organisational means necessary to allow access to the products by ROINTE for repair or replacement.

2.5. ROINTE's Technical Support department will advise you if you need to purchase any parts not covered by this guarantee or outside of this guarantee.

2.6. This guarantee will not be valid if the product has been tampered with, modified and/or repaired in any way and/or by unauthorised persons. This guarantee will also not be valid if the product is not correctly installed.

2.7. This guarantee is not transferable and does not include claims for limescale or frost damage.

2.8. This guarantee does not affect the purchaser's statutory rights under applicable national legislation, nor does it affect any rights contracted with the dealer or installer that may arise in performance of the contract of sale.

2.9. ROINTE, its offices, employees, distributors and installers shall not be liable for any incidental damages arising from the infringement of any rule implied in this product, as well as for its improper or incorrect use.

2.10. Check the EULA conditions (supplied with the product for Wi-Fi connected products) for information on the legal agreement you accept when installing a ROINTE product. For product or guarantee assistance, please contact ROINTE by telephone at +44 (0)203 321 5929 or by email to support@rointe.co.uk.

10. HOW TO REGISTER YOUR PRODUCT GUARANTEE

IMPORTANT: It is important that you register your ROINTE product as part of our guarantee service, in case you wish to make a claim.

You can register your ROINTE product in the following ways:

WEB

1. Go to <https://rointe.com/uk/register-your-guarantee/>
2. Log in to your existing account or create a new account if necessary.
3. Click on "My products".
4. Enter your product reference (alphanumeric and in capital letters).
5. Enter your serial number (26 digits located on the metal tag of your product starting with 84).
6. Upload your proof of purchase, such as your invoice in PDF, JPEG or PNG format. This is not mandatory, but doing so ensures that your warranty period is accurate.
7. Click on "Register".
8. Congratulations! Your product is now registered.

EMAIL

1. Send an email to support@rointe.com with the following information:
 - Customer name
 - Address and postcode
 - Telephone number and email address
 - Product reference
 - Serial number
 - The date of purchase of the product and proof of purchase (as described in the WEBSITE section above).
 - Our technical support team will confirm product registration and request any additional information needed by email.

POSTAL

1. Send the information listed in the EMAIL section to:
 - INDUSTRIAS ROYAL TERMIC, S.L. - Rointe, C/E Parcela 43, 30140, Santomera (ESPAÑA).
2. Please ensure you obtain proof of postage.