

**KYROS** Low consumption digital radiator / Radiador digital de bajo consumo / Radiador digital economizador de energia

EN

**INSTALLATION AND USER MANUAL**

Page 03

ES

**MANUAL DE INSTALACIÓN Y USO**

Página 31

PT

**MANUAL DE INSTALAÇÃO E DE UTILIZAÇÃO**

Página 58

**GUARANTEE / GARANTÍA  
/ GARANTIA**

**10**

YEARS / AÑOS  
/ ANOS

**3**

YEARS / AÑOS  
/ ANOS

ON THE BODY  
EN EL CUERPO  
NO CORPO

ON ELECTRONICS  
EN ELECTRÓNICA  
NA ELECTRÓNICA

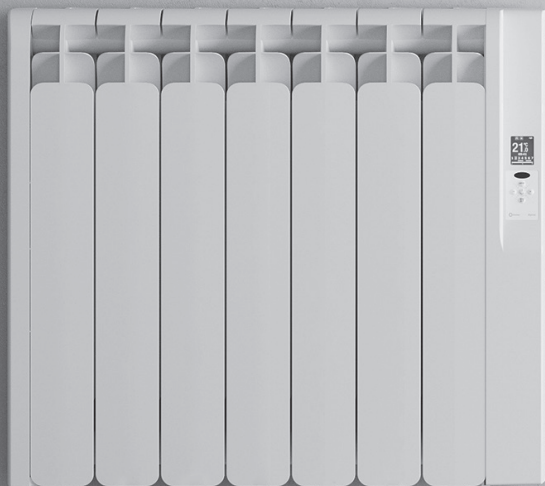

---

## SYMBOLS



**DANGER.** This symbol indicates a medium-high risk hazard which can result in serious injury or even death.



**DO NOT COVER.** Do not dry or leave clothes or towels on the radiator. Do not leave or place magazines, spray cans, volatile substances, or similar objects within 250 mm of the radiator.



**HOT SURFACE.** This symbol indicates that your surfaces are hot during and immediately after use. These must not be touched: danger of burns.



**OBSERVE THE INSTRUCTIONS IN THE MANUAL.** Please read this manual carefully before installing and using the product. Keep it for later use. Read all instructions and safety warnings. Failure to follow these can result in electric shock, fire or serious injuries.

## INDEX

1. General Warnings .....	5
2. Technical information .....	8
3. Installation.....	9
4. Screen & Keypad .....	12
5. Functionality and programming .....	13
5.1. ON / OFF (stand-by) .....	13
5.2. Adjust the day and time.....	13
5.3. Adjust the temperature .....	14
5.4. Lock the control panel .....	14
5.5. Main menu .....	15
5.6. Main menu: Submenu settings .....	15
5.7. Main Menu: Energy sub-menu .....	16
5.8. Main menu: Equilibrium / Balance sub-menu .....	18
5.9. Main menu: Program sub-menu .....	18
5.9.1. Manual/Automatic functions .....	19
5.9.2. Programming options .....	19
5.9.3. User mode.....	23
5.10. Energy saving functionalities .....	25
6. Maintenance and cleaning .....	25
7. European Regulation (WEEE) 2012/19/EU .....	26
8. Guarantee .....	26
9. How to register your product guarantee .....	29
Directive ERP Commission Regulation .....	84
EU Declaration of Conformity .....	85

## 1. GENERAL WARNINGS



### WARNINGS

This product may be used by children over 8 years of age and by persons with reduced physical, sensory, or mental capabilities, or lack of experience and knowledge under strict supervision or instruction in the safe use of the product and if they understand the hazards involved. Children should not plug, adjust, clean, play with, or perform maintenance on this product. Children under 3 years of age should be kept away from this product unless supervised.

DO NOT use the product in enclosed spaces if the persons present cannot leave the room independently and are not under constant supervision.



DO NOT COVER. To avoid overheating, do not cover the radiator.

DO NOT place spray cans, volatile substances, or similar objects within 250mm of the product.

DO NOT use insecticides, paints, or chemicals on or near the product.



Some parts of this product could reach high temperatures and cause burns. DO NOT touch the external parts of the product when in operation.

DO NOT install near curtains or other flammable materials.

Particular attention should be paid when children and vulnerable people are present.

When using electrical appliances, precautions should be taken to reduce the risk of fire, electric shock and injury.

Never insert fingers, body parts or objects inside the product.

Make sure that the voltage indicated on the product's technical information corresponds to the voltage output you have at your socket.

Any repair or maintenance that requires the product to be opened the product must be carried out by personnel authorised by ROINTE, who must also be notified if a leak is observed. Only official spare parts approved by ROINTE should be used. Please observe the current and relevant regulations when disposing of this product and its thermal fluid.

If the power cable is damaged, it must be replaced by personnel authorised by ROINTE to prevent any damage.

To avoid the risk of suffocation, do not leave the packaging including bags and other items within reach of babies or children.

The product has an IP24 degree of protection and can be used in bathrooms, but not in the vicinity of bathtubs, taps, showers, water connections, toilets, swimming pools or other masses of water. The product must never be installed where it, the switches or the control panel are within the reach of people in the water. Never use the product with wet hands. Do not place any water containers (glasses, vases, etc.) on or near the product.



## IMPORTANT

- Disconnect the product from the power supply and make sure the product is at room temperature before any cleaning or maintenance. Do not use any abrasive substances on the product, such as (but not limited to) chemicals, coarse cloths, brushes, hard bristle, or wire/steel wool.
- To disconnect the product from the power source, remove the mains plug from the socket. Do not pull on the cable.
- ROINTE cannot be held responsible for incorrect sizing of the product unless it has been followed by an official ROINTE technical study.
- Before the first start-up, or before the start of winter, or when the product has not been used for many days, the appliance should be cleaned (follow the steps in the “maintenance” section of this manual).
- Do not sit or lean on the product.
- Temperature contrasts can generate “clicks” or noises in the device. This is not a fault of the product, but due to the expansion/contraction of the materials.
- When disposing of the product, the requirements set out in the legislation for the waste treatment and recycling must be followed. See WEEE in section 7.

## 2. TECHNICAL INFORMATION

MODELS	0330RAD3	0550RAD3	0770RAD3	0990RAD3	1210RAD3	1430RAD3	1600RAD3
Number of elements	3	5	7	9	11	13	15
<b>DIMENSIONS, WEIGHTS &amp; FINISHES</b>							
Width (mm)	350	510	670	830	990	1,150	1,310
Height (mm)	580	580	580	580	580	580	580
Depth (mm)	95	95	95	95	95	95	95
Installed depth (mm)	118	118	118	118	118	118	118
Weight (kg)	7.7	12.2	16.4	20.1	24.1	27.8	32.1
Finish	White RAL 9016						
<b>ELECTRICAL CHARACTERISTICS</b>							
Nominal power (W)	330	550	770	990	1,210	1,430	1,600
Effective power (W)	125	209	293	376	460	543	608
Voltage (V)	230 ~V	230 ~V	230 ~V	230 ~V	230 ~V	230 ~V	230 ~V
Current (A)	1.5	2.4	3.4	4.3	5.3	6.2	7.0
<b>SAFETY &amp; INSTALLATION</b>							
Safety thermostat	✓	✓	✓	✓	✓	✓	✓
Protection Grade	IP24	IP24	IP24	IP24	IP24	IP24	IP24
Template & Installation Kit	✓	✓	✓	✓	✓	✓	✓
EAN CODE	8436045917256	8436045917263	8436045917270	8436045917287	8436045917294	8436045917300	8436045917317



### 3. INSTALLATION

We recommend using a trusted Rointe supplier for installation of the product. Find the nearest one by calling us on **0203 321 5929** or using the locator on **www.rointe.co.uk**.

**IMPORTANT:** Prior to installation, please locate the metal tag located at the back of the product and note the product reference and serial number. You will need this information to register your guarantee. See section 9 for help on how to register the guarantee.

**WARNING:** Do not install the product directly over an electrical outlet or junction box. Do not install the product or use it outdoors. Do not install directly under a shelf. This product is designed to be installed on an interior wall using the ROINTE template, the installation kit and the fixings supplied. Do not install the product in such a way that it encounters the power cable.

The product must be mounted on the wall in the position shown in the accompanying image using the brackets and with the fixings supplied.

Our products transfer heat through the natural air convection. If the product is covered, this will disrupt the airflow and could cause overheating. It must be positioned in accordance with the minimum distances shown in the accompanying picture.

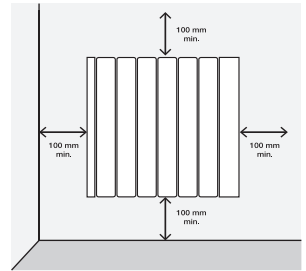

**WARNING:** The product has an IP24 degree of protection and can be used in bathrooms, but not in the vicinity of bathtubs, taps, showers, water connections, toilets, swimming pools or other masses of water. The product can only be installed in zone 3 of the accompanying picture. The product must never be installed where it, the switches or the control panel are within the reach of people in the water. Never use the product with wet hands. Do not place any water containers (glasses, vases, etc.) on or near the product.

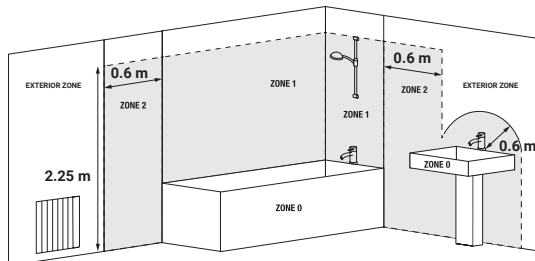

An installation kit is included in the product packaging. You will need a drill, a rubber mallet, a spirit level and a pencil to complete the installation.

**WARNING:** The weight of some of the products may be heavy. The installation may require two people.



**IMPORTANT:** Please follow these instructions carefully.

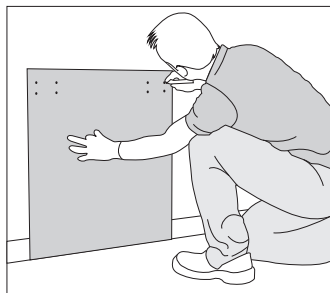

1. Remove the packaging and check that the installation contains brackets, screws, rawl plugs and a cardboard template.

2. Select a suitable location on the wall. Place the template on the wall and mark the holes for the brackets and screws. Observe the minimum distance requirements from the previous page.

**Use the floor as a base for the template, not the skirting board.**

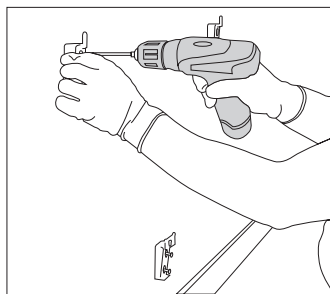

3. Remove the template and carefully drill out the marked holes.

4. Secure the upper brackets with the rawl plugs and screws provided. Then fix the lower bracket. **To distinguish it, the lower bracket has a different design from the top ones.**

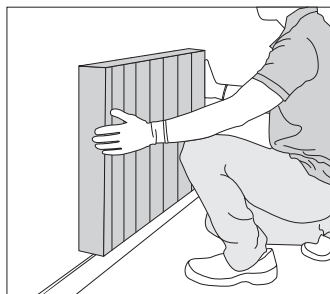
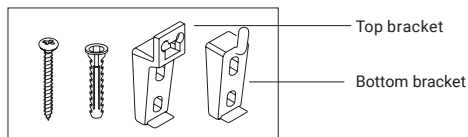

5. Slide the product up and down over the fixed brackets.

6. Check the straightness with a spirit level and adjust the supports accordingly if necessary.

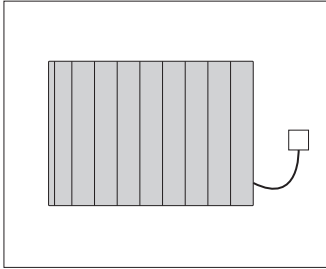

7. Connect your product to the power supply and switch it on.

8. See section 5 for operating instructions.

**IMPORTANT:** Measurement template per model.

**KR\*0330RAD3**

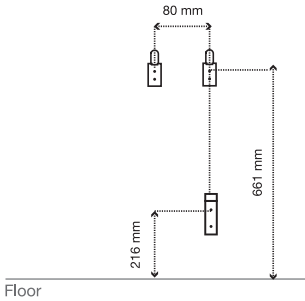

**KR\*0550RAD3**

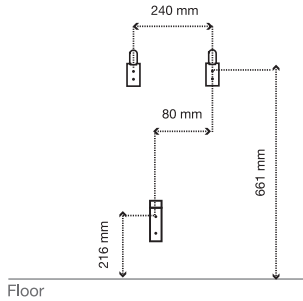

**KR\*0770RAD3**

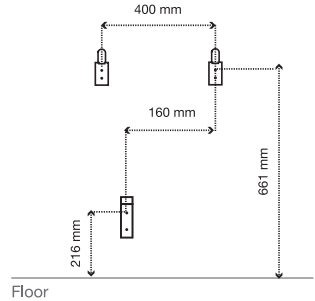

**KR\*0990RAD3**

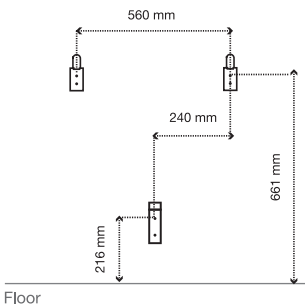

**KR\*1210RAD3**

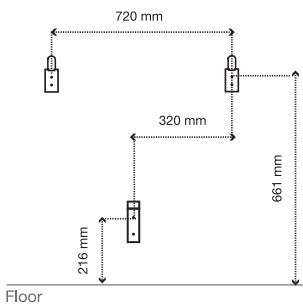

**KR\*1430RAD3 /  
KR\*1600RAD3**

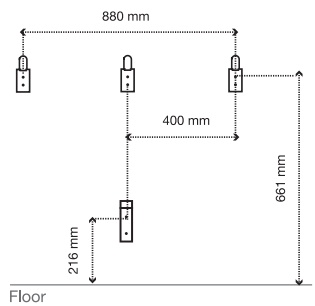

## 4. SCREEN & KEYPAD

Decrease temperature  
Move left

Increase temperature  
Move right

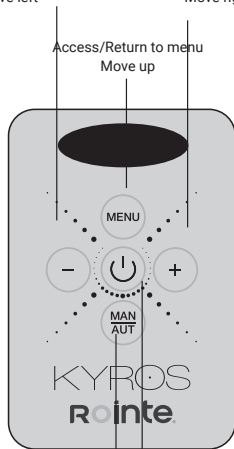



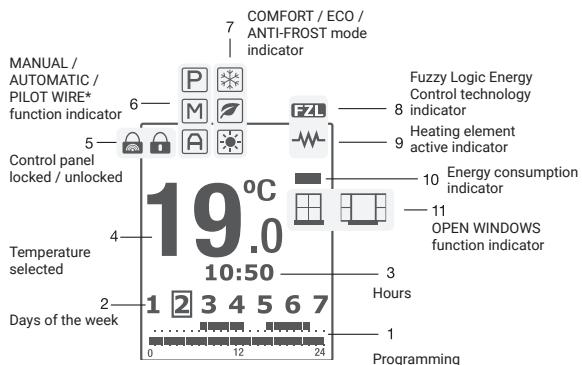

MANUAL / AUTOMATIC button On / Off  
Move down Accept / Confirm







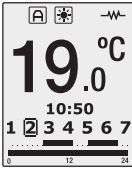





SYMBOL	DESCRIPTION	SYMBOL	DESCRIPTION
	OPEN WINDOWS function - active no detection		AUTOMATIC function - active
	OPEN WINDOWS function - active, detection		MANUAL function - active
	Energy consumption status - green / amber / red		PILOT WIRE function - active <b>* Only on demand.</b>
	Heating element - active		AUTOMATIC function - active when USER mode active
	Fuzzy Logic Energy Control technology active		MANUAL function - active when USER mode active
	COMFORT mode - active		PILOT WIRE function - active when USER mode active <b>* Only on demand.</b>
	ECO mode - active		Control panel locked through keypad
	ANTI-FROST mode - active		Control panel locked through remote

## 5. FUNCTIONALITY & PROGRAMMING

### 5.1. ON / OFF (STAND BY)

<p>To switch the product on, please press the  button on the keypad once.</p>	
<p>After 3 seconds the temperature, time and weekday display is shown.</p>	
<p>To switch the product off, please press the  button again once.</p> <p>The product will go into stand-by mode with the word 'STAND-BY' displayed on the display panel. After 3 seconds the Rointe logo will appear.</p>	

### 5.2. ADJUST THE DAY & TIME

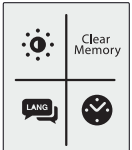
<p>Press the menu button  to access the main menu. Use the  and , (left and right respectively), select the configuration submenu , and press the button. Press the  button to access.</p>	
<p>Now use the  and  buttons again to select the clock option  and press  to access.</p>	

Use the **⊖** and **⊕** buttons to set the hour and then press **⏻** to confirm. Then use the **⊖** and **⊕** buttons to set the minutes and press **⏻** to confirm. Finally, use the **⊖** and **⊕** buttons to set the day (1 = Monday, 2 = Tuesday etc.) and confirm by pressing the **⏻** button. The screen will automatically revert to the main one or wait 30 seconds for it to do so.

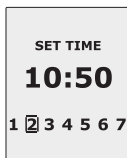

## 5.3. ADJUST THE TEMPERATURE

To decrease the temperature press the **⊖** button and to increase the temperature press the **⊕** button.

When the room temperature is lower than the set temperature on the display panel, the product will come on with the  symbol appearing in the top right of the display panel.

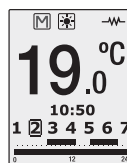

When the Fuzzy Logic Energy Control technology is activated the symbol **FZL** will replace the heating element active symbol  in the top right of the screen.

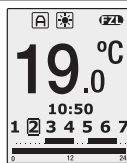

## 5.4. LOCK THE CONTROL PANEL

You can lock the keypad from the product or from a Rointe remote control (sold separately).

To lock the keypad manually, please hold and press the **⊖** button AND the **⊕** button TOGETHER for 3 seconds. The  symbol will appear on the display panel and the keys will not respond. To unlock the keypad manually, please hold and press the **⊖** button AND the **⊕** button TOGETHER for 3 seconds.



\*To lock the keypad using a remote control, please see the corresponding instruction manual for the remote control separately.



When locked from the remote control, the remote keypad lock icon  will appear on the screen. When pressing any key on the product, the image on the right will be displayed on the screen. The remote keypad lock can only be unlocked from the remote control.







## 5.5. MAIN MENU

To access the main menu of your product, press the  button. To move through the various submenus that appear, use the  and  buttons.





The selected option will be highlighted with a flashing frame; to access the selected submenu, press the  button.

The icons that allow you to enter the different submenus are listed below:



			
Settings	Energy	Equilibrium	Programming



## 5.6. MAIN MENU: SUBMENU SETTINGS





The settings submenu adjusts four technical parameters of your product. To access it, select the icon  in the main menu and confirm by pressing the  button. The screen on the right will appear and you can move through the different submenu options using the  and  buttons.

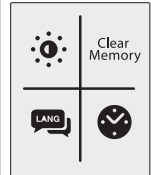

The following icons allow access to the different submenus explained below:

	Clear Memory		
Screen brightness	Clear memory	Language	Time



### • Adjust display backlight brightness

This allows you to change the brightness of the display panel in both the STAND-BY and ON modes separately. To change the brightness of the display panel ensure the  icon is highlighted and press the  button to confirm. Then with the  and  buttons you can switch between the two modes.

With the  and  buttons you can increase or decrease the brightness as you wish. The cursor indicates the intensity of the light. Once you have set the required brightness press the  button to save and exit.

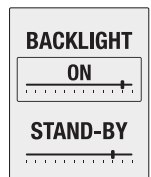

## • Clear the memory



This allows you to clear any information saved in your product.



To clear the memory ensure the <sup>Clear</sup>Memory icon is highlighted in the 'Settings' sub-menu and press the  button to confirm.

The display panel will show when completed and the language will change to default.

**MEMORY  
CLEARED**

## • Change the language

To change the language of your product, ensure the  icon is highlighted in the 'Settings' sub-menu and press the  button to access.

Use the  and  buttons to move up or down respectively until your chosen language is highlighted and confirm by pressing the  button.

**LANGUAGE**  
ENGLISH  
FRANÇAIS  
ESPAÑOL  
PORTUGUÊS



## • Adjust the day and time

This function sets the hour, minute and day of the week from the product itself. To set the time and day, please go to section 5.2.

SET TIME  
**10:50**  
1 2 3 4 5 6 7



## 5.7. MAIN MENU: ENERGY SUB-MENU

The 'Energy' sub-menu provides access to functions related to energy management of the product. To access, select the  icon displayed in the Main Menu screen and press  to confirm.

Use the  and  buttons to move across the different options on the sub-menu to choose your function and press  to confirm.

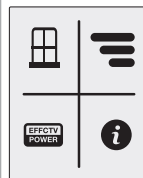

The below icons displayed on the screen take you to the following functions:



			
OPEN WINDOWS function	Energy Consumption status	Effective Power function	Information





• **OPEN WINDOWS function**

This option allows you to activate or deactivate the WINDOWS OPEN function. Using the and buttons  and , select ON to activate and OFF to deactivate. Once the desired option has been selected, press  to confirm and exit.

This function is activated when there is a drop of at least 4°C in the room temperature within 30 minutes. This normally occurs when a window is left open, allowing warm air to escape and wasting energy. If this occurs, your product will automatically activate the Anti-freeze mode for 2 hours. To deactivate this function, press the on/off button.



• **Energy Consumption status**

To check the current consumption status of your product, ensure the  icon is highlighted in the 'Energy' sub-menu and press the  button to access.

The display panel will then show a status according to the current state of consumption of the product:



**Up to 40%**  
effective power





**40% - 60%**  
effective power





**More than 60%**  
effective power

• **Effective Power function**

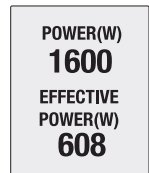
To check the Power status of your product, make sure the  icon is flashing in the 'Energy' submenu and press the  button to access. This option shows on the display the actual consumption time of the product and the total time during which our product is connected to the mains. After a few seconds without pressing any button, the display will show the nominal power and the effective power of the product. The effective power corresponds to the average power value that our product actually consumes during operation.





## • Information



This function will display the software version, the date of this release and the rated power of the product. To access this information, ensure the  icon is highlighted in the 'Energy' sub-menu and press the  button to confirm. The information will then show in the display panel

**SOFTWARE  
VERSION**  
**V3.65**  
11/11/2021  
**POWER 1600W**

## 5.8. MAIN MENU: EQUILIBRIUM / BALANCE SUB-MENU

The 'Balance' sub-menu/function returns the product to a constant temperature of 19°C. To activate this function ensure the  icon is highlighted in the 'Balance' sub-menu and press the  button to confirm.

The product will return to the display panel in MANUAL function, with the temperature set to 19°C.

M    
**19.0**  
10:50  
1 2 3 4 5 6 7



## 5.9. MAIN MENU: PROGRAM SUB-MENU



This section explains the operational aspects of your product in its various functions and modes.



### What are the functions of MANUAL, AUTOMATIC and PILOT WIRE functions?

<b>MANUAL</b>	This function allows you to change the product between the COMFORT, ECO and ANTI-FROST modes and to change the temperature (see section 5.3.).
<b>AUTOMATIC</b>	This function will activate the programming that has previously been set in the product.
<b>PILOT WIRE</b>	This function allows the product to be controlled by a central programmer. * Not available in UK. Only on demand*

### What are the COMFORT, ECO and ANTI-FROST modes?

 COMFORT	 ECO	 ANTI-FROST
From 19°C to 30°C	From 7.5°C to 18.5°C	7°C

The 'Program' sub-menu provides access to functions related to programming the product. To access, select the  icon displayed in the Main Menu screen and press  to access.



Use the  and  buttons to move across the different options on the sub-menu to choose your program and press  to access.

The icons displayed on the screen take you to the following functions:





MAN / AUTO		USER	PILOT
MANUAL / AUTOMATIC functions	Programming options	USER mode	PILOT WIRE function * Not available in UK. Only on demand.*

### 5.9.1. MANUAL / AUTOMATIC FUNCTIONS

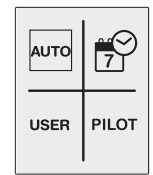
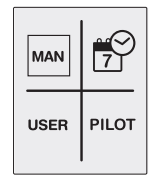



To change or choose the MANUAL or AUTOMATIC function, ensure the **MAN/AUTO** icon is highlighted in the 'Program' sub-menu and press the  button to confirm. You can change from AUTOMATIC to MANUAL and vice versa by pressing the  button again.

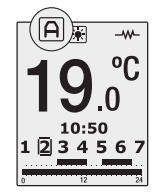
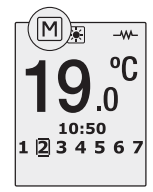





On the display panel, the symbol  will appear for the AUTOMATIC function and the symbol  for the MANUAL function.

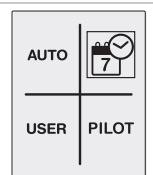

### 5.9.2. PROGRAMMING OPTIONS

To access the programming options, ensure you are in the 'Program' sub-menu, then select the  icon by using the  and  buttons and then press the  button once the  icon is highlighted.

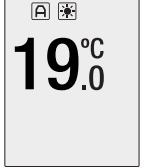
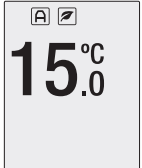

<p>The display panel will show 2 options:</p> <ul style="list-style-type: none"> <li>• PRE-PROGRAMS: one of the four pre-set schedules.</li> <li>• START PROGRAMMING: to set a personalised programming and change the values of the COMFORT and ECO modes.</li> </ul> <p>A flashing line will appear around the option that is selected. To change the option use the <b>⊖</b> and <b>⊕</b> buttons and press the <b>⏻</b> button to confirm.</p>	 <p>PREPROGRAMS A1 A2 A3 A4 START PROGRAMMING</p>
<p>Start programming for AUTOMATIC function</p> <p>To program the AUTOMATIC mode, see points above and ensure that START PROGRAMMING is highlighted. Press the <b>⏻</b> button to access and the display panel will show a flashing screen.</p> <p>STEP 1 - Select COMFORT mode temperature</p> <p>✱ COMFORT mode will be programmed first. Select the COMFORT mode temperature between 19°C and 30°C using the <b>⊖</b> and <b>⊕</b> buttons. The ✱ icon and the temperature will flash. Press the <b>⏻</b> button to confirm.</p>	 <p>19.0°C</p>
<p>STEP 2 - Select ECO mode temperature</p> <p>🍃 ECO mode will be programmed next. Select the ECO mode temperature between 7.5°C and 18.5°C. The 🍃 icon and the temperature will flash. Press the <b>⏻</b> button to confirm.</p>	 <p>15.0°C</p>
<p>STEP 3 - Select the Days</p> <p>The days of the week will start flashing on the display panel and show as DAY 1, DAY 2, DAY 3 etc.</p> <p>Use the <b>⊖</b> and <b>⊕</b> buttons to move forwards or backwards through the days. Press <b>⏻</b> to select the day or days that you wish to include in your AUTOMATIC program. The day will stop flashing once selected. Repeat for all the days you wish to program and once all days are selected press the button <b>⊕</b> to move onto setting the hour.</p>	 <p>DAY 1</p> <p>1 2 3 4 5 6 7</p>

**STEP 4 - Select the Hours**

Once step 3 has been completed, 0h appears on the display panel. 0h is equal to midnight. Use the **-** or **+** buttons to select the hour you wish to change. Use the **⏻** button to change the mode (COMFORT, ECO or nothing) for the hour you wish to modify. The corresponding icon for that mode will appear at the top of the screen. To finish the programming press **MENU** or leave for 30 seconds without pressing any buttons. To change the programming go back to step 1 and proceed as described before.

\*If you wish to have individual days with different programming within your program you will need to modify each day separately, starting from the Main Menu again for each day/days. Follow Steps 1 to 4 above to program multiple differing days/hours/temperatures.

If you want to activate the anti-frost mode in the hours that do not have COMFORT or ECO mode, from the main screen of the radiator and in automatic mode, press the key **+**. If you want to reverse this action, press **MENU**.

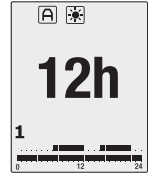

- PRE-PROGRAMS**

To activate a PRE-PROGRAM for your product ensure that PRE-PROGRAM is highlighted in the 'Program' sub-menu. Press the **⏻** button to confirm and the display panel will show 4 programs for you to choose from: A1, A2, A3 and A4.

Using the **-** and **+** buttons, choose the program you wish to activate and once highlighted, press the **⏻** button to confirm. You will then be automatically taken back to the main display panel and your pre-program option will show on the screen to confirm it is active.



To MODIFY any of the pre-set programs:

You need to be in AUTOMATIC mode and select the pre-program you want to modify i.e. your product must be working/have the pre-program already activated you wish to modify.

Then ensure that START PROGRAMMING is highlighted. Press the **⏻** button to access and the display panel will show a flashing screen. You then need to follow STEPS 1 - 4 on pages 11 & 12 to modify the temperature/day/hours.

\*If you wish to have different days with different programming within your program you will need to modify each day separately, starting from the Main Menu again for each day/days. Follow STEPS 1 - 4 on pages 11 & 12 to program multiple differing days/hours/temperatures.

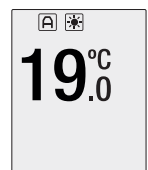
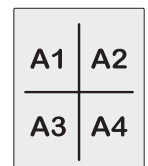

• Pre-installed programmes schedule:

PROGRAM	A1		A2		A3	A4	
	Mon - Fri	Sat - Sun	Mon - Fri	Sat - Sun	Mon - Sun	Mon - Fri	Sat - Sun
00:00							
01:00							
02:00							
03:00							
04:00							
05:00							
06:00	COMFORT		COMFORT		COMFORT		
07:00	COMFORT	COMFORT	COMFORT	COMFORT	COMFORT	COMFORT	ECO
08:00	COMFORT	COMFORT	COMFORT	COMFORT	COMFORT	COMFORT	ECO
09:00	COMFORT	COMFORT	COMFORT	COMFORT	COMFORT	COMFORT	ECO
10:00	ECO	COMFORT	ECO	COMFORT	COMFORT	COMFORT	ECO
11:00	ECO	ECO	COMFORT	ECO	COMFORT	COMFORT	ECO
12:00	ECO	COMFORT	COMFORT	COMFORT	COMFORT	COMFORT	ECO
13:00	ECO	COMFORT	COMFORT	COMFORT	COMFORT	COMFORT	ECO
14:00	ECO	COMFORT	COMFORT	COMFORT	COMFORT	COMFORT	ECO
15:00	COMFORT	COMFORT	ECO	COMFORT	COMFORT	COMFORT	ECO
16:00	COMFORT	ECO	ECO	ECO	COMFORT	ECO	ECO
17:00	COMFORT	ECO	COMFORT	ECO	COMFORT	ECO	ECO
18:00	COMFORT	ECO	COMFORT	ECO	COMFORT	ECO	ECO
19:00	COMFORT		COMFORT	COMFORT	COMFORT	ECO	ECO
20:00	COMFORT		COMFORT	COMFORT	COMFORT	ECO	ECO
21:00	COMFORT		COMFORT	COMFORT	COMFORT	ECO	ECO
22:00	COMFORT		COMFORT	COMFORT	COMFORT	ECO	ECO
23:00	ECO				ECO		

COMFORT
ECO
ANTI-FROST

### 5.9.3. USER MODE

To enter the USER function, ensure the **USER** icon is highlighted in the 'Program' sub-menu and press the button to access. A 4-digit PIN code is required in order to access the menu. The default PIN is 0000.

To enter the PIN use the and and and buttons to move left, right, up or down to select the correct numbers, pressing after each number is highlighted to confirm. Once the full 4 digits have been entered, move to OK on the display panel and press the button to confirm. Once the PIN number has been entered correctly, the main USER function sub-menu will be shown.

The below icons displayed on the screen take you to the following functions:

ENABLE / DISABLE functions	Change PIN	Upper temperature limit	Lower temperature limit

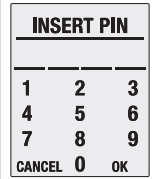

#### • Enable / Disable functions

To access the Enable/Disable function, ensure the icon is highlighted in the 'Program' sub-menu and press the button to access.



Use the and buttons to move up and down respectively to select ON to enable or OFF to disable. Once the desired option is highlighted press the button to confirm. Use the button to go back to the main display panel or leave for 30 seconds without pressing any buttons.

On the main screen you will see the icon in AUTOMATIC function, the icon in MANUAL function and when in PILOT WIRE function.

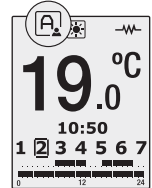
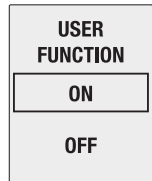
**\*PILOT WIRE function not available in UK. Only on demand.**



## • Change the PIN code

To change the PIN code of your product, ensure the  icon is highlighted in the 'Program' sub-menu and press the  button to access.

Use the  and  and  and  buttons to move left, right, up or down to select the new numbers, pressing  after each number is highlighted to confirm.



Then move to OK on the display panel and press the  button to confirm. The screen will show PIN CHANGED.





Please remember your new PIN code for the future and store in a safe place. In order to access the USER function menu again you will need your new PIN code.

NEW PIN		
1	2	3
4	5	6
7	8	9
CANCEL	0	OK





## • Upper temperature limit



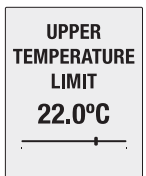

To set the upper temperature limit of your product ensure the  icon is highlighted in the 'Program' sub-menu and press the  button to access.

Use the  and  buttons to decrease or increase your desired upper temperature between 19°C to 30°C and press the  button to confirm. You will then return to the USER function screen. To exit press the  button to go back to the main display panel or leave for 30 seconds without pressing any buttons.



## • Lower temperature limit

To set the lower temperature limit of your product ensure the  icon is highlighted in the 'Program' sub-menu and press the  button to access.



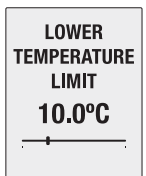



Use the  and  buttons to decrease or increase your desired lower working temperature between 7.5°C to 18.5°C and press the  button to confirm. You will then return to the USER function screen. To exit press the  button to go back to the main display panel or leave for 30 seconds without pressing any buttons.







- **PILOT WIRE function (\*Not available in UK. Only on demand.)**

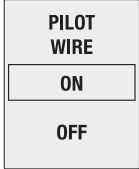
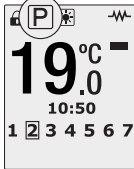

The PILOT WIRE function allows your heating only to be controlled via a pilot wire programmer.

<p>To access the PILOT WIRE mode, ensure the <b>PILOT</b> icon is highlighted in the 'Program' sub-menu and press the  button to access.</p> <p>Use the  and  buttons to move up and down respectively to select ON to enable or OFF to disable. Once the desired option is highlighted press the  button to confirm. Use the  button to go back to the main display panel or leave for 30 seconds without pressing any buttons.</p> <p>On the main display panel the symbol  will appear.</p>		
--	---	--

## 5.10. ENERGY SAVING FUNCTIONALITIES

- **Tecnología FUZZY LOGIC ENERGY CONTROL**

Fuzzy Logic Energy Control is a technology developed by Rointe to improve the energy management required to maintain a stable temperature, analyzing its variations with an accuracy of  $\pm 0.25$  °C and sending micro electrons to the heating element that transfer the heat to the atmosphere in the most efficient way. When the  icon on the display panel is replaced with the , then the Fuzzy Logic Energy Control technology has been activated and is working.

When the symbol  replaces the symbol , then the FUZZY LOGIC ENERGY CONTROL technology is in operation.

- **Temperature/efficiency setting indicator**

The temperature setting indicator is shown on the product display to indicate what temperature level has been set in the programming, which directly affects your consumption. A green indicator means that the temperature is set between 7 - 18.5°C. A red indicator is between 25°C - 30°C. This indicator appears automatically and cannot be altered manually.

## 6. MAINTENANCE AND CLEANING

The product does not require any maintenance. We recommend cleaning the product (back, bottom of the product, etc.). Do not use abrasive substances on the product, clean it with a damp cloth and neutral pH soap and the screen with a dry cloth. Before carrying out any cleaning operation, make sure that the product is switched off and at room temperature.

## 7. EUROPEAN REGULATION (WEEE) 2012/19/EU

Based on the European regulation 2012/19/EU on Waste Electrical and Electronic Equipment (WEEE), these appliances cannot be thrown in the usual council bins; they must be collected selectively to optimise the recovery and recycling of the components and materials that make them up, and reduce the impact on human health and the environment. The crossed-out wheelie bin symbol on a horizontal bar is marked on all ROINTE products to remind the consumer of the obligation to separate them for separate collection. The consumer should contact the local authority or the retailer for information regarding the correct disposal of their product.





## 8. GUARANTEE

### 1. Agreement

1.1. This section describes the guarantee conditions available to the buyer when purchasing a new product of the Rointe brand. These conditions include all the rights that the buyer has in accordance with current national legislation, as well as the guarantee and additional rights offered by the brand. Any incident detected in your Rointe product can be dealt with by the seller of the product or in a more agile way through the manufacturer itself.

1.2. Rointe offers you Technical Assistance from our After-Sales Service by telephone at +44 (0)203 321 5929 or email to support@rointe.co.uk, where we will indicate the steps to follow to solve the incident. You will need the product reference (located on the metal characteristics label), serial number, date of purchase and the nature of the fault when contacting us. In addition, you must have a copy of the proof of purchase of the product.

1.3. ROINTE guarantees there are no material defects of design or manufacture at the time of original purchase. ROINTE guarantees the body for 120 months (10 years) and the electrical plus electronic components for 36 months (3 years) for this product only, from the date of purchase, or delivery if later, provided it has not been modified, and in accordance with the provisions of the following stipulations.

	<b>Rointe</b>			
REFERENCE	REF: KRI0770RAD3		IP 24	
SERIAL NUMBER	INPUT: 230 V~ 50Hz 550W			
	S/N: 8436045913715000001			
	KYROS			

## 2. Conditions

2.1. If during the guarantee period, the product under normal use, and with proper maintenance, fails to function properly and is found to be defective in design, material, or workmanship, it will be repaired or replaced at the customer's option, in accordance with the provisions of the law, and subject to the following terms and conditions:

2.1.1. The guarantee is only applicable if the original guarantee is issued by the seller and when such guarantee has been registered with Rointe correctly, including the product reference, serial number (marked on the metal label of the product), date of purchase and proof of purchase. The product guarantee can be registered on our website at [www.rointe.co.uk](http://www.rointe.co.uk) or can be emailed to [support@rointe.co.uk](mailto:support@rointe.co.uk) within 90 days of installation. ROINTE reserves the right to refuse a guarantee when this information has been removed or modified after the original product purchase.

2.1.2. The guarantee is only applicable if the product has been installed by a competent person in accordance with this installation manual and all regulations in force at the time of installation.

2.1.3. The guarantee is only applicable to those cases that refer to defects in material, design and manufacture, and in no case covers damage to the product for the following reasons:

- i) Damage caused by negligence and/or misuse of the product, i.e. used for purposes other than its normal use, or by not respecting the instructions for use, maintenance and cleaning given by ROINTE, as well as by incorrect or inadequate installation or use of the product that may not comply with the technical safety standards in force.
- ii) Corrosion of any part of the product caused by direct exposure to saltwater. Where the product is installed within 200 m of the coast, the guarantee period for damage caused by corrosion shall be reduced by 50%.
- iii) Any unauthorised modifications or repairs to the product carried out by third parties or unauthorised persons, or the opening of the product by third parties or unauthorised persons.
- iv) Any accident deemed to be beyond ROINTE's control, such as (but not limited to): lightning, fire, flood, natural disasters, public disorder, atmospheric or geological phenomena, and all those of a similar nature.
- v) Failures resulting from incorrect installation. In case of doubt, please contact ROINTE.

2.2. Any repair or replacement carried out as part of this guarantee service does not allow for extension periods or new guarantee periods, i.e. your guarantee will not be extended in the event that a repair or replacement of this product is carried out, but will be suspended until the product is returned repaired or a new one is delivered.

2.3. Any repair or replacement covered by this guarantee must be a functionally equivalent part. Defective parts or parts removed or replaced shall become the property

of ROINTE and must be returned as such.

2.4. The product must be installed in such a way as to allow access by ROINTE technicians or authorised persons in the event that they need to access the product for repair or maintenance. The user/customer is responsible for the organisational means necessary to allow access to the products by ROINTE for repair or replacement.

2.5. ROINTE's Technical Support department will advise you if you need to purchase any parts not covered by this guarantee or outside of this guarantee.

2.6. This guarantee will not be valid if the product has been tampered with, modified and/or repaired in any way and/or by unauthorised persons. This guarantee will also not be valid if the product is not correctly installed.

2.7. This guarantee is not transferable and does not include claims for limescale or frost damage.

2.8. This guarantee does not affect the purchaser's statutory rights under applicable national legislation, nor does it affect any rights contracted with the dealer or installer that may arise in performance of the contract of sale.

2.9. ROINTE, its offices, employees, distributors and installers shall not be liable for any incidental damages arising from the infringement of any rule implied in this product, as well as for its improper or incorrect use.

2.10. Check the EULA conditions (supplied with the product for Wi-Fi connected products) for information on the legal agreement you accept when installing a ROINTE product. For product or guarantee assistance, please contact ROINTE by telephone at +44 (0)203 321 5929 or by email to [support@rointe.co.uk](mailto:support@rointe.co.uk).

## 9. HOW TO REGISTER YOUR PRODUCT GUARANTEE

**IMPORTANT:** It is important that you register your ROINTE product as part of our guarantee service, in case you wish to make a claim.

You can register your ROINTE product in the following ways:

### **WEB**

1. Go to <https://rointe.com/uk/register-your-guarantee/>
2. Log in to your existing account or create a new account if necessary.
3. Click on "My products".
4. Enter your product reference (alphanumeric and in capital letters).
5. Enter your serial number (26 digits located on the metal tag of your product starting with 84).
6. Upload your proof of purchase, such as your invoice in PDF, JPEG or PNG format. This is not mandatory, but doing so ensures that your warranty period is accurate.
7. Click on "Register".
8. Congratulations! Your product is now registered.

### **EMAIL**

1. Send an email to [support@rointe.com](mailto:support@rointe.com) with the following information:
  - Customer name
  - Address and postcode
  - Telephone number and email address
  - Product reference
  - Serial number
  - The date of purchase of the product and proof of purchase (as described in the WEBSITE section above).
  - Our technical support team will confirm product registration and request any additional information needed by email.

### **POSTAL**

1. Send the information listed in the EMAIL section to:
  - INDUSTRIAS ROYAL TERMIC, S.L. - Rointe, C/E Parcela 43, 30140, Santomera (ESPAÑA).
2. Please ensure you obtain proof of postage.



## SÍMBOLOS



**PELIGRO.** Este símbolo indica un peligro con un riesgo medio elevado el cual, si no se evita, puede resultar en una lesión seria o incluso la muerte.



**NO CUBRIR.** No se debe secar la ropa o toallas sobre el radiador ni dejar telas, revistas, botes de spray, sustancias volátiles u objetos similares a menos de 250 mm del radiador.



**SUPERFICIE CALIENTE.** Este símbolo indica que sus superficies están calientes durante e inmediatamente después de su uso. Estas no deben ser tocadas: peligro de quemaduras.



**OBSERVE LAS INSTRUCCIONES EN EL MANUAL.** Por favor, lea cuidadosamente el manual antes de instalar y utilizar el producto. Guárdelo para su uso posterior. Lea todas las instrucciones y advertencias de seguridad. Un fallo en el seguimiento de estas puede resultar en una descarga eléctrica, incendio, así como heridas graves.

## ÍNDICE

1. Advertencias generales .....	33
2. Información técnica .....	36
3. Instalación .....	37
4. Teclado y pantalla .....	40
5. Funcionalidad y programación .....	41
5.1. Encendido y apagado .....	41
5.2. Ajustar día y hora .....	41
5.3. Selección de temperatura .....	42
5.4. Bloqueo del panel de control .....	42
5.5. Menú principal.....	43
5.6. Menú principal: Submenú de configuración.....	43
5.7. Menú principal: Submenú de energía.....	44
5.8. Menú principal: Submenú equilibrio.....	46
5.9. Menú principal: Submenú programación.....	46
5.9.1. Funciones manual/automático.....	47
5.9.2. Programación .....	47
5.9.3. Modo usuario.....	51
5.10. Funcionalidades de ahorro energético .....	53
6. Mantenimiento y limpieza .....	53
7. Normativa Europea (RAEE) 2012/19/UE .....	53
8. Garantía .....	54
9. Cómo registrar la garantía de su producto .....	56
Directiva ERP Reglamento de la Comisión .....	84
Declaración UE de conformidad .....	85



## 1. ADVERTENCIAS GENERALES



### ADVERTENCIAS

Este producto puede ser utilizado por niños mayores de 8 años y por personas con capacidades físicas, sensoriales o mentales reducidas, o con falta de experiencia y conocimientos, bajo supervisión o instrucción sobre el uso del producto de manera segura y comprenden los peligros que conlleva. Los niños no deben enchufar, regular, limpiar, jugar ni realizar mantenimiento en este producto. Los niños menores de 3 años deben mantenerse alejados del producto a menos que sean supervisados.

No usar el dispositivo en espacios cerrados si hay personas presentes que no pueden abandonar la habitación independientemente y no están bajo constante supervisión.



**NO CUBRIR.** Para evitar sobrecalentamientos, no cubrir el radiador.

No colocar botes de spray, sustancias volátiles u objetos similares a una distancia inferior a 250mm del producto. No utilice insecticidas, pinturas, productos químicos sobre o cerca del producto.



Algunas partes de este producto podrían alcanzar temperaturas altas y causar quemaduras. No tocar las partes externas del emisor cuando esté en funcionamiento. No instalar cerca de cortinas u otros materiales inflamables. Se debe prestar especial atención cuando niños y personas vulnerables estén presentes.

Al utilizar aparatos eléctricos, se deben tomar precauciones para reducir el riesgo de incendio, descarga eléctrica y lesiones a las personas. Nunca introducir, dedos, partes del cuerpo u objetos en el interior del producto.

Asegurarse que el voltaje indicado en la información técnica del producto se corresponde con la salida de voltaje con la que usted cuenta en su enchufe.

Cualquier reparación o mantenimiento que requiera abrir el producto debe ser realizada por ROINTE o por personal autorizado, que también debe ser notificado si se observa una fuga. Se deben utilizar únicamente las piezas de recambio oficiales aprobadas por el fabricante. Por favor, respete las normas al desechar este producto y su fluido térmico.

Si el cable de alimentación está dañado, debe ser sustituido por ROINTE o por su personal autorizado para evitar cualquier daño.

Para evitar riesgos de asfixia, no dejar las bolsas y demás accesorios al alcance de bebés y niños.

El producto tiene un grado de protección IP24 y puede utilizarse en cuartos de baño, pero no en las inmediaciones de bañeras, duchas, conexiones de agua, lavabos, piscinas u otras masas de agua. El producto no debe instalarse nunca donde él mismo, o los interruptores o el panel de control estén al alcance de las personas dentro del agua. Nunca utilice el producto con las manos mojadas. No coloque ningún recipiente de agua (vasos, jarrones, etc.) sobre o cerca del producto.

## ! IMPORTANTE

- Desconecte el producto de la fuente de alimentación y asegúrese de que el producto esté a temperatura ambiente antes de cualquier limpieza o mantenimiento. No utilice ninguna sustancia abrasiva sobre el producto, como (pero no limitado a) productos químicos, paños ásperos, cepillos de cerdas duras o lana de alambre/acero.
- Para desconectar el producto de la fuente de alimentación principal, retire el enchufe de la toma. Nunca tire del cable.
- ROINTE no puede hacerse responsable de los productos con un dimensionamiento incorrecto, a menos que se haya seguido un estudio técnico oficial de ROINTE.
- Antes del primer arranque o antes del comienzo de la campaña de invierno o cuando el emisor no se ha usado durante muchos días, el aparato debe ser limpiado (siga los pasos del punto "mantenimiento" de este manual).
- No se siente o apoye sobre el producto.
- Los contrastes de temperatura pueden generar "chasquidos" o ruidos en el aparato. Esto no es un fallo del producto, sino que se debe a la dilatación/contracción de los materiales.
- Cuando se desechen los emisores, deben tenerse en cuenta los requisitos establecidos por la legislación para el tratamiento y reciclaje de los residuos. Ver RAEE en punto 7.

## 2. INFORMACIÓN TÉCNICA

MODELOS	0330RAD3	0550RAD3	0770RAD3	0990RAD3	1210RAD3	1430RAD3	1600RAD3
Número de elementos	3	5	7	9	11	13	15
<b>DIMENSIONES, PESO Y ACABADOS</b>							
Anchura (mm)	350	510	670	830	990	1.150	1.310
Altura (mm)	580	580	580	580	580	580	580
Profundidad (mm)	95	95	95	95	95	95	95
Profundidad instalada (mm)	118	118	118	118	118	118	118
Peso (kg)	7,7	12,2	16,4	20,1	24,1	27,8	32,1
Acabados	Blanco RAL 9016						
<b>CARACTERÍSTICAS ELÉCTRICAS</b>							
Potencia nominal (W)	330	550	770	990	1.210	1.430	1.600
Potencia efectiva (W)	125	209	293	376	460	543	608
Voltaje (V)	230 ~V	230 ~V	230 ~V	230 ~V	230 ~V	230 ~V	230 ~V
Intensidad (A)	1,5	2,4	3,4	4,3	5,3	6,2	7,0
<b>SEGURIDAD E INSTALACIÓN</b>							
Termostato de seguridad	✓	✓	✓	✓	✓	✓	✓
Grado de protección	IP24	IP24	IP24	IP24	IP24	IP24	IP24
Plantilla y kit de instalación	✓	✓	✓	✓	✓	✓	✓
CÓDIGO EAN	8436045917454	8436045917461	8436045917478	8436045917485	8436045917492	8436045917508	843605917515

### 3. INSTALACIÓN

Recomendamos usar un proveedor de confianza de Rointe. Encuentre el más cercano llamándonos al **900 103 061** o usando el localizador en **www.rointe.com**.

**IMPORTANTE:** Previo a la instalación, por favor localice la etiqueta metálica situada en la parte posterior del producto y anote la referencia del producto y el número de serie. Necesitará esta información para registrar su garantía. Ver apartado 9 para indicar el registro de la garantía.

**ADVERTENCIA:** No instale el producto directamente sobre una toma de corriente fija o caja de conexiones. No instale el producto ni lo use en el exterior. No la instale directamente debajo de un estante. Este producto está diseñado para ser instalado en una pared interior utilizando la plantilla ROINTE, el kit de instalación y los elementos de fijación suministrados. No instalar el producto de forma que quede en contacto con cable de alimentación.

El producto debe ser montado en la pared en la posición mostrada en la imagen adjunta usando los soportes y con las fijaciones suministradas.

Nuestros productos transfieren el calor a través de la convección natural del aire. Si el producto está cubierto, esto interrumpirá el flujo de aire y podría causar sobrecalentamiento. Debe colocarse de acuerdo con las distancias mínimas que se muestran en la imagen.

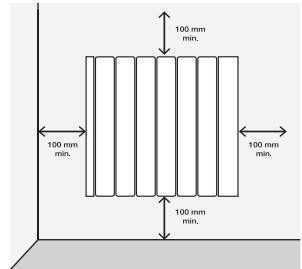

**ADVERTENCIA:** El producto tiene un grado de protección IP 24 y puede utilizarse en cuartos de baño, pero no en las inmediaciones de bañeras, duchas, conexiones de agua, lavabos u otras masas de agua. Sólo puede instalarse en la zona 3. El producto nunca debe instalarse donde él mismo o los interruptores/panel de control estén al alcance de las personas en el agua.

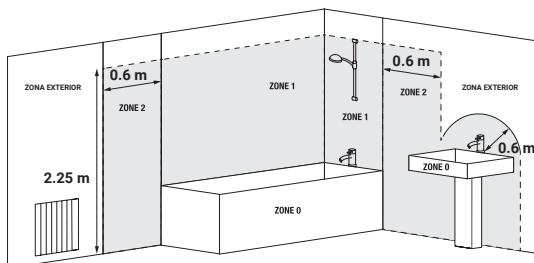

Dentro del embalaje del producto encontrará un kit de instalación. Necesitará un taladro, un mazo de goma, un nivel y un lápiz para completar la instalación.

**ADVERTENCIA.** El peso de algunos de los productos podría ser elevado. Su instalación puede requerir la intervención de dos personas.

**IMPORTANTE:** Por favor, siga estas instrucciones cuidadosamente.

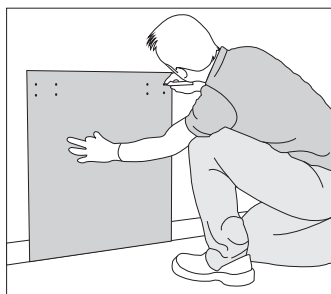

1. Quite el embalaje y compruebe que el kit de instalación contiene soportes, tornillos, tacos y plantilla de cartón.
2. Seleccione el lugar adecuado de la pared. Coloque la plantilla en la pared y marque los agujeros para los soportes y los tornillos. Observe los requisitos de distancia mínima de la página anterior.

**Utilice el suelo como base para la plantilla, no el rodapié.**

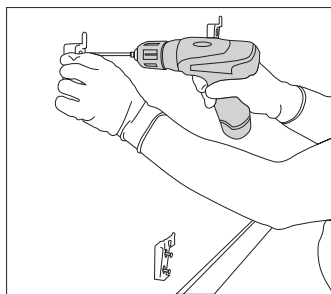

3. Retire la plantilla y taladre cuidadosamente los agujeros marcados.
4. Fije los soportes superiores con los tacos y tornillos suministrados. Luego fije el soporte inferior.

**NOTA:** Para distinguirlo, el soporte inferior tiene un diseño diferente a los superiores.

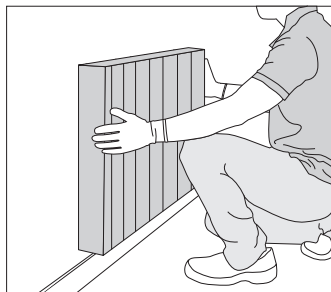
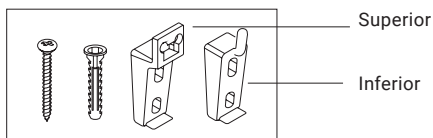

5. Deslice el producto de arriba a abajo sobre soportes fijos.
6. Compruebe la rectitud con un nivel y ajuste los soportes en consecuencia si es necesario.

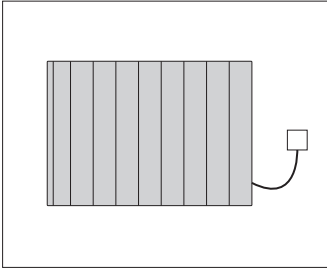

1. Conecte su producto al suministro eléctrico y enciéndalo.
2. Consulte la sección 5 para ver las instrucciones de funcionamiento.

**IMPORTANTE:** Plantilla de medidas por modelo.

**KR\*0330RAD3**

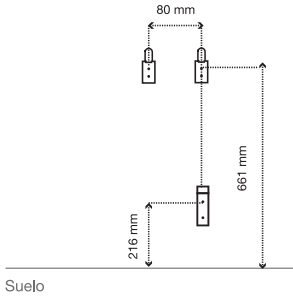

**KR\*0550RAD3**

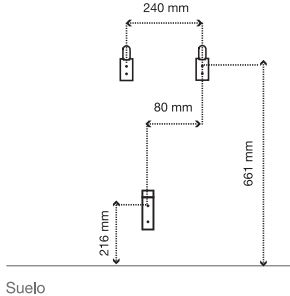

**KR\*0770RAD3**

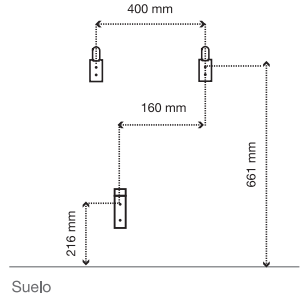

**KR\*0990RAD3**

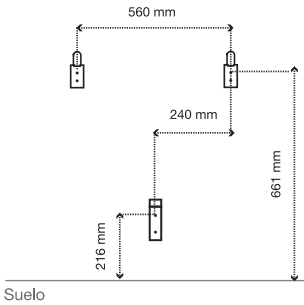

**KR\*1210RAD3**

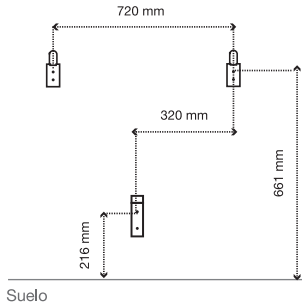

**KR\*1430RAD3 /  
KR\*1600RAD3**

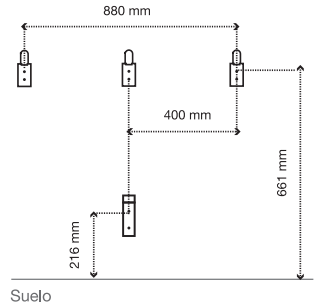

## 4. TECLADO Y PANTALLA

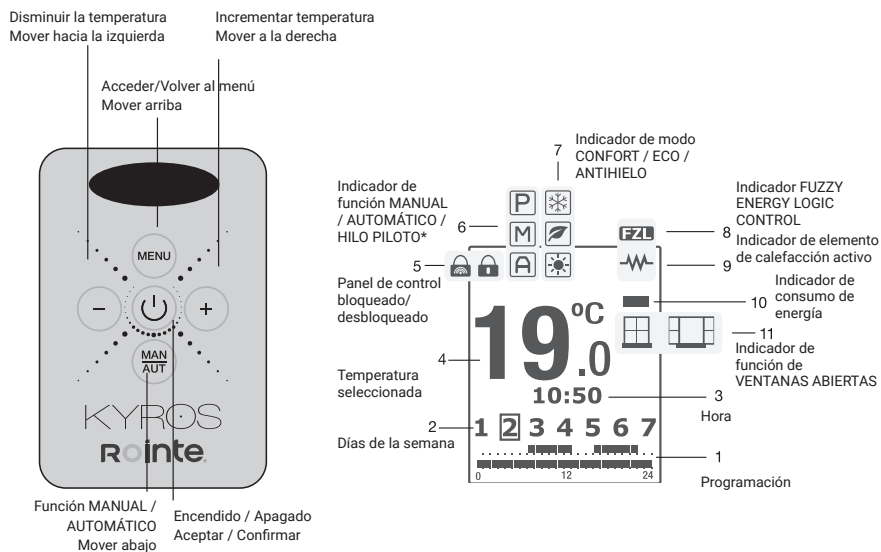





SÍMBOLO	DESCRIPCIÓN	SÍMBOLO	DESCRIPCIÓN
	Función VENTANAS ABIERTAS - detectado		Función AUTOMÁTICO - activo
	Función VENTANAS ABIERTAS - activo		Función MANUAL - activo
	Indicador de consumo de energía - verde / amarillo / rojo		Función HILO PILOTO - activo *No disponible en España. Sólo bajo demanda.
	Elemento de calefacción - activo		Función AUTOMÁTICO - activo en modo USUARIO
	Tecnología FUZZY ENERGY LOGIC CONTROL - activo		Función MANUAL - activo en modo USUARIO
	Modo CONFORT - activo		Función HILO PILOTO - activo en modo USUARIO. No disponible en España. Solo bajo demanda.*
	Modo ECO - activo		Bloqueo a través del panel de control
	Modo ANTIHIELO - activo		Bloqueo a través del mando













## 5. FUNCIONALIDAD Y PROGRAMACIÓN

### 5.1. ENCENDIDO Y APAGADO (STAND BY)

<p>Una pulsación corta sobre la tecla  apaga o enciende el producto.</p>	
<p>Pasados 3 segundos, se visualiza la pantalla de temperatura, hora y días de la semana.</p>	
<p>Para apagar el producto, presione de nuevo el botón , apareciendo la palabra 'STAND BY' en la pantalla. Pasados 5 segundos aparecerá el logo de Rointe.</p>	

### 5.2. AJUSTAR DÍA Y HORA

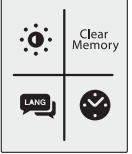
<p>Pulsando el botón  se accede al menú principal. Usando los botones  y , que dirigen a la izquierda y a la derecha respectivamente, se selecciona el submenú de configuración , el cuál se encuentra parpadeando, pulsando  para acceder.</p>	
<p>Ahora use los botones  y  para seleccionar la opción reloj  y pulse  para acceder.</p>	

Use los botones **⊖** y **⊕** para establecer la hora, confirmando con el botón **⏻** después. Pulse de nuevo los botones **⊖** y **⊕** para establecer los minutos y confirme con **⏻**. Finalmente, pulse los botones **⊖** y **⊕** para establecer el día (1 = lunes, 2 = martes, etcétera) y confirme con **⏻**. Una vez confirmado, sale automáticamente la pantalla inicial o espere 30 segundos.

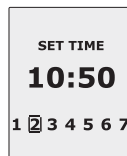

## 5.3. SELECCIÓN DE TEMPERATURA

Con las teclas **⊖** o **⊕** se puede cambiar la temperatura de consigna. Aumentando la temperatura con la tecla **⊕**, y disminuyendo la temperatura con la tecla **⊖**. Si la temperatura de la estancia es inferior a la seleccionada, el producto entra en consumo, apareciendo el símbolo **⚡** en la parte superior derecha de la pantalla.

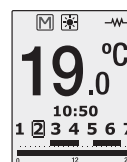

Cuando la tecnología Fuzzy Logic Energy Control entre en funcionamiento, el logo **FZL** aparecerá en la pantalla en el lugar donde se encontraba el símbolo de resistencia activa **⚡**.

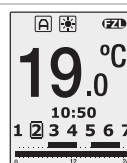

## 5.4. BLOQUEO DEL PANEL DE CONTROL

Es posible bloquear el producto desde el propio producto o desde los mandos (no incluidos).



Desde el propio producto, pulsando simultáneamente durante 3 segundos los botones **⊖** y **⊕** se bloquea el teclado encendiéndose el icono de bloqueo de teclado **🔒**. Al pulsar cualquier tecla aparecerá en la pantalla la imagen de la derecha. Para desbloquear, debe pulsar de nuevo las teclas **⊖** y **⊕** durante 3 segundos. Para bloquear el teclado usando su mando a distancia (no incluido), vea por favor el manual de instrucciones del mismo por separado.



Cuando se bloquea desde el mando a distancia, aparecerá en la pantalla el icono de bloqueo remoto de teclado **🔒**. Al pulsar cualquier tecla del producto, en la pantalla se mostrará la imagen de la derecha. El bloqueo remoto de teclado tan sólo puede desbloquearse desde el mando.







## 5.5. MENÚ PRINCIPAL

Para acceder al menú principal de su producto, pulse el botón . Para moverse por los distintos submenús que aparecen, utilice los botones  y .





La opción seleccionada aparecerá resaltada con un marco parpadeante; se accederá al submenú seleccionado pulsando el botón .

A continuación, se detallan los iconos que permiten entrar a los distintos submenús:



			
Submenú configuración	Submenú energía	Función de equilibrio	Submenú programación



## 5.6. MENÚ PRINCIPAL: SUBMENÚ DE CONFIGURACIÓN



El submenú configuración ajusta cuatro parámetros técnicos de su producto. Para acceder, seleccione el icono  del menu principal y confirme pulsando el botón . Aparecerá la pantalla de la derecha y podremos movernos por las distintas opciones del submenú utilizando los botones  y .



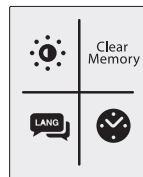

Los siguientes iconos permiten acceder a los distintos submenús que se explican a continuación:

	Clear Memory		
Iluminación de la pantalla	Memoria borrada	Idioma	Hora



### • Ajustar la iluminación de la pantalla

Esta función permite cambiar el brillo de la pantalla para los modos STAND-BY y ACTIVO (ON). Para acceder a esta función, asegúrese de que el icono  está parpadeando en el submenú y presione  para confirmar.

Con los botones  y  intercambiamos entre las dos opciones. Con los botones  y  podemos aumentar o reducir el valor de iluminación.

El cursor indica la intensidad de iluminación seleccionada dentro del rango. Una vez terminado pulsaremos  para confirmar y salir.

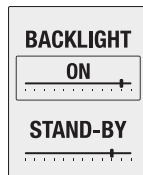



## • Memoria borrada



Esto le permite borrar cualquier información guardada en su producto pulsando  para confirmar.

Cuando se pulsa esta función, el idioma por defecto cambiará al de fábrica.

**MEMORY  
CLEARED**

## • Idioma

Para acceder a esta función, asegúrese de que el icono  está parpadeando en el submenú y presione  para confirmar.

Esta función permite seleccionar el idioma preferido para poder comunicarse con el producto. Con los botones  y  seleccione el idioma y pulse  para confirmar el idioma subrayado.

**LANGUAGE**

ENGLISH

FRANÇAIS

**ESPAÑOL**

PORTUGUÊS

## • Ajustar día y hora

Esta función ajusta la hora, los minutos y el día de la semana desde el propio producto. Para ajustar la hora y el día, vea por favor el punto 5.2.

**SET TIME**

**10:50**





1 2 3 4 5 6 7

## 5.7. MENÚ PRINCIPAL: SUBMENÚ DE ENERGÍA



El submenú energía da acceso a las funciones relacionadas con la gestión energética del producto.

Seleccione, mediante las teclas  y  el icono  del menú principal. Pulse  para acceder a esta pantalla.

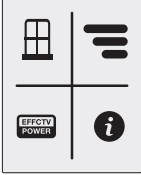
Los siguientes iconos permiten acceder a los distintos submenús:

				
Función VENTANAS ABIERTAS	Estado de consumo de energía	Función de potencia efectiva	Información	

• **Función VENTANAS ABIERTAS**

Esta opción permite activar o desactivar la función VENTANAS ABIERTAS. Con los botones  y , seleccione ON para activar y OFF para desactivar. Una vez marcada la opción deseada pulse  para confirmar y salir.

Esta función se activa cuando se produce una disminución de al menos 4°C de la temperatura ambiente en un periodo de 30 minutos. Normalmente ocurre cuando se deja una ventana abierta, dejando escapar el aire caliente y desperdiciando energía. Si esto ocurre, su producto activará automáticamente el modo Antihielo durante 2 horas. Para desactivar esta función, pulse el botón de encendido/apagado.



• **Estado de consumo de energía**

Esta función muestra el estado de consumo para alertar al usuario si el producto funciona correctamente o hay un problema que hace que el producto tenga un consumo excesivo.

Cuando se pulsa la tecla , aparece una de las siguientes pantallas de acuerdo con el estado de consumo del producto:



Hasta el 40% de la potencia efectiva





Entre 40% y 60% de la potencia efectiva





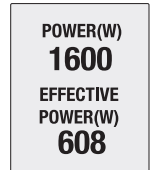

Más del 60% de la potencia efectiva

• **Función potencia efectiva**

Para comprobar el estado de Potencia efectiva de su producto, asegúrese que el icono  parpadea en el submenú 'Energía' y presione el botón  para acceder. Esta opción muestra en la pantalla el tiempo de consumo real del producto y el tiempo total durante el cual nuestro producto se encuentra conectado a la red eléctrica. Transcurridos unos segundos sin pulsar ningún botón, la pantalla mostrará la potencia nominal y la potencia efectiva del mismo. La potencia efectiva corresponde al valor de potencia media que realmente nuestro producto consume durante su funcionamiento.









## • Información

Esta opción muestra la versión de software, la fecha de lanzamiento y la potencia nominal del producto. Se accede seleccionando el icono  del submenú energía mediante los botones  y  y pulsando  para confirmar. Para salir de la pantalla de información, pulse .

**SOFTWARE  
VERSION  
V3.65**  
11/11/2021  
**POWER 1600W**

## 5.8. MENÚ PRINCIPAL: SUBMENÚ EQUILIBRIO

El submenú equilibrio hace que el producto trabaje en función Manual con una temperatura constante de 19 °C. Acceda seleccionando desde el menú principal el icono equilibrio  usando las teclas  y . Confirme mediante una pulsación de la tecla . Una vez pulsado, el producto vuelve a la pantalla principal, con la temperatura establecida en 19°C y el icono función MANUAL encendido.

    
**19.0**  
10:50  
1 2 3 4 5 6 7

## 5.9. MENÚ PRINCIPAL: SUBMENÚ PROGRAMACIÓN





En este apartado explicamos los aspectos relacionados con el funcionamiento del producto en sus distintas funciones y modos.

### ¿Qué son las funciones MANUAL, AUTOMÁTICO y HILO PILOTO?

<b>MANUAL</b>	Esta función permite intercambiar entre los modos de trabajo CONFORT, ECO y antihielo, modificando la temperatura como se indicó en el punto 5.3.
<b>AUTOMÁTICO</b>	Esta función activa la programación que tenga grabada el producto.
<b>HILO PILOTO</b>	Esta función permite controlar el producto desde una central externa conectada por hilo piloto. *Función HILO PILOTO no disponible en España. Sólo bajo demanda.

### ¿Qué son los modos CONFORT, ECO y ANTIHIELO?



 CONFORT	 ECO	 ANTIHIELO
Desde 19°C a 30°C	Desde 7,5°C a 18,5°C	7°C

El submenú programación da acceso a las funciones relacionadas con la programación del producto. Acceda seleccionando el icono  del menú principal; usando, para moverse por la pantalla, los botones  y  y presionando después  para confirmar. Los iconos que se exponen más abajo, permiten acceder a los distintos submenús que se explican a continuación:

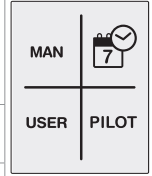

<b>MAN/AUTO</b>		<b>USER</b>	<b>PILOT</b>
Funciones MANUAL / AUTOMÁTICO	Opciones de programación	Modo USUARIO	Modo HILO PILOTO * No disponible en España. Sólo bajo demanda.



### 5.9.1. FUNCIONES MANUAL/AUTOMÁTICO

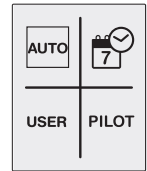
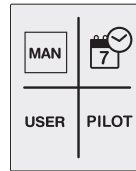



Para cambiar o elegir entre las funciones MANUAL o AUTOMÁTICO, asegúrese de que el icono **MAN/AUTO** esté parpadeando y pulse el botón  para confirmar. Pulse el botón  para intercambiar entre las funciones MANUAL y AUTOMÁTICO. La función AUTOMÁTICO activa la programación establecida en el producto.

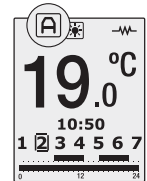
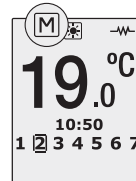

En la pantalla principal aparecerá el símbolo  para la función AUTOMÁTICO y el símbolo  para la función MANUAL.



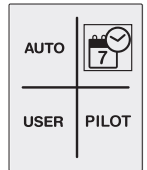

### 5.9.2. PROGRAMACIÓN

Para comenzar la programación, pulse sobre el icono parpadeante  usando los botones  y  y confirmado mediante la tecla .



















En la pantalla aparecerán dos opciones para seleccionar:

- PREPROGRAMACIÓN: una de las cuatro programaciones pre-establecidas.
- START PROGRAMMING: para establecer una programación personalizada y cambiar los valores de los modos CONFORT y ECO.

La opción parpadeará cuando se seleccione. Use los botones  y  para cambiar y pulsando  para confirmar.



<ul style="list-style-type: none"> <li>• START PROGRAMMING para modo AUTOMÁTICO</li> </ul> <p>Para programar el modo AUTOMÁTICO, mire los puntos anteriores y asegúrese que START PROGRAMMING está seleccionado. Presione el botón  para confirmar y el pantalla le mostrará una pantalla iluminada.</p> <p>PASO 1 - Seleccione temperatura modo CONFORT</p> <p> El modo CONFORT será programado primero. Seleccione temperatura modo CONFORT entre 19°C y 30°C usando los botones  y . El icono  y la temperatura parpadearán. Presione  para confirmar.</p>	
<p>PASO 2- Seleccione temperatura modo ECO</p> <p> Modo ECO será programado a continuación. Seleccione la temperatura modo ECO entre 7,5°C y 18,5°C . El icono  y la temperatura parpadearán. Presione  para confirmar.</p>	
<p>PASO 3 - Seleccione el día</p> <p>Los días de la semana empezarán a parpadear en la pantalla y se mostrará como DÍA 1, DÍA 2, DÍA 3, etc.</p> <p>Use los botones  y  para moverse delante o detrás por los días expuestos. Presione  para seleccionar el día o los días que usted desee para incluirlos en su programa AUTOMÁTICO. El día parará de parpadear una vez seleccionado. Repita el proceso para todos los días que usted desee programar y una vez tenga todos los días seleccionados presione el botón  para pasar a configurar la hora.</p>	



**PASO 4 - Seleccione las horas**

Una vez completado el paso 3, 0h aparecerá en la pantalla (0h equivale a medianoche). Use los botones **-** y **+** para seleccionar la hora que usted desee cambiar. Use el botón **⏸** para cambiar (el modo CONFORT, ECO o nada), para la hora que usted desee modificar. El correspondiente icono aparecerá para cada modo.

Para finalizar la programación presione **⏸** o espere 30 sg sin presionar ningún botón. Para cambiar la programación vaya atrás hasta el paso 1 y proceda según lo descrito anteriormente.

Si usted desea activar el modo anti-hielo en las horas que no tienen modo CONFORT o ECO, desde la pantalla principal del radiador y en modo automático, pulse la tecla **+**. Si quiere revertir esta acción, pulse **⏸**.

\*Si usted desea modificar una programación diferente para distintos días, usted deberá modificar cada día por separado; empezando desde el menú principal para cada día o días a modificar. Siga de los pasos 1 hasta el 4 para programar diferentes días, horas y temperaturas.

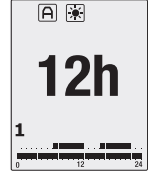

- **PREPROGRAMACIÓN** - para ELEGIR una PREPROGRAMACIÓN para su producto:

Asegúrese que PRE-PROGRAMS está seleccionado. Presione el botón **⏸** para confirmar y la pantalla le mostrará 4 programas a elegir: A1, A2, A3 y A4.

Usando los botones **-** y **+**, elija el programa que usted desee activar y una vez parpadee, presione el botón **⏸** para confirmar. Automáticamente la pantalla retrocederá a la pantalla principal y su opción preprogramada será mostrada en la pantalla para ser confirmada.



Para modificar cualquiera de los programas establecidos:

Usted necesita estar en modo AUTOMÁTICO, y seleccionar el preprograma que desee modificar.

Después, diríjase a **START PROGRAMMING** y presione **⏸** para confirmar. Siga después los pasos del 1-4 de las páginas 18-19 de este manual, para cambiar la temperatura/día/hora.

\*Si usted desea diferentes programaciones en varios días, deberá modificar cada día o grupo de días por separado; empezando desde el menú principal para cada día o días a modificar. Siga de los pasos 1 hasta el 4 para programar diferentes días, horas y temperaturas.

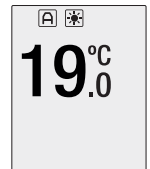
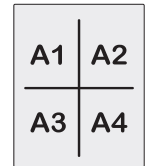

• Programaciones pre-instaladas:

PROGRAMA	A1		A2		A3	A4	
	Lun - Vie	Sáb - Dom	Lun - Vie	Sáb - Dom	Lun - Dom	Lun - Vie	Sáb - Dom
00:00							
01:00							
02:00							
03:00							
04:00							
05:00							
06:00	CONFORT		CONFORT		CONFORT		
07:00	CONFORT	CONFORT	CONFORT	CONFORT	CONFORT	CONFORT	ECO
08:00	CONFORT		CONFORT		CONFORT		ECO
09:00	CONFORT		CONFORT		CONFORT		ECO
10:00	ECO	CONFORT	ECO	CONFORT	CONFORT	CONFORT	ECO
11:00	ECO	ECO	CONFORT	ECO	CONFORT	CONFORT	ECO
12:00	ECO	CONFORT	CONFORT	CONFORT	CONFORT	CONFORT	ECO
13:00	ECO		CONFORT		CONFORT		ECO
14:00	ECO		CONFORT		CONFORT		ECO
15:00	CONFORT	CONFORT	ECO	CONFORT	CONFORT	CONFORT	ECO
16:00	CONFORT	ECO	ECO	ECO	CONFORT	ECO	ECO
17:00	CONFORT		CONFORT	ECO	CONFORT		ECO
18:00	CONFORT		CONFORT	ECO	CONFORT		ECO
19:00	CONFORT		CONFORT	CONFORT	CONFORT		ECO
20:00	CONFORT		CONFORT	CONFORT	CONFORT		ECO
21:00	CONFORT		CONFORT	CONFORT	CONFORT		ECO
22:00	CONFORT		CONFORT	CONFORT	CONFORT		ECO
23:00	ECO				ECO		

CONFORT
ECO
ANTI-HIELO

### 5.9.3. MODO USUARIO

Al seleccionar esta opción, se permite asignar un límite superior e inferior a la temperatura de consigna.

Para acceder al modo USUARIO, asegúrese de que el icono **USER** esta parpadeando en el submenú y presione para confirmar.

Será necesario un PIN de cuatro dígitos para acceder al menú. El pin establecido por defecto es el 0000. Para introducir el PIN use los botones y y y para moverse a la izquierda, derecha, arriba y abajo respectivamente y confirme pulsando tras cada número que quiera cambiar y esté parpadeando. Una vez estén correctamente puestos los 4 dígitos, sitúese en el OK y pulse para confirmar. Una vez completado este proceso de forma correcta, las funciones de submenú deseadas serán mostradas.

A continuación, le mostramos los distintos iconos que permiten acceder a los distintos submenús:



INSERT PIN		
1	2	3
4	5	6
7	8	9
C	0	OK

	 ****		
Activar/ desactivar modo USUARIO	Cambiar el código PIN	Límite de temperatura máxima	Límite de temperatura mínima

#### • Activar / Desactivar Modo USUARIO

Asegúrese en primer lugar que el icono se encuentra parpadeando y confirme con el botón . Con las teclas y , arriba y abajo respectivamente, seleccione ON para activar y OFF para desactivar. Una vez marcada la opción deseada, pulse para confirmar. Use el botón para volver al menú principal, o espere 30 segundos sin pulsar ningún botón.



En la parte superior de la pantalla principal aparecerá el icono para función AUTOMÁTICO y para función MANUAL.



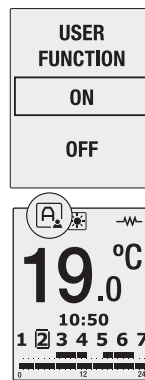

En el caso en que nos encontremos en función de control por HILO PILOTO, aparecerá en la pantalla principal el icono .

\*Función HILO PILOTO no disponible en España. Sólo bajo demanda.\*



## • Cambiar el código PIN

Para cambiar el código PIN de su producto, asegúrese que está sobre el icono  parpadeando en el menú y presione  para confirmar.

Esta función permite cambiar la contraseña para acceder al modo Usuario. Seleccione los números del nuevo PIN usando los botones , ,  y . Una vez realizado el proceso, acepte pulsando OK, apareciendo la pantalla PIN CHANGED para confirmar el cambio.







Por favor, asegúrese de recordar su nuevo PIN en caso de modificarlo.

NEW PIN		
1	2	3
4	5	6
7	8	9
CANCEL	0	OK



**PIN CHANGED**

## • Límite de temperatura máxima







Asegúrese que está sobre el icono  parpadeando en el menú y presione  para confirmar. Esta función permite modificar la temperatura máxima de trabajo del producto. Con los botones  y  se puede aumentar o reducir la temperatura entre los 19°C y 30°C. Una vez seleccionado el valor deseado, pulse  para salir. Para salir, pulse el botón  o espere 30 sg.

**UPPER TEMPERATURE LIMIT**

**22.0°C**



## • Límite de temperatura mínima

Asegúrese que está sobre el icono  parpadeando en el menú y presione  para confirmar. Esta función permite modificar la temperatura mínima de trabajo del producto. Con los botones  y  se puede aumentar o reducir la temperatura entre los 7°C y 18,5°C. Una vez seleccionado el valor deseado, pulse  para salir. Para salir, pulse el botón  o espere 30 sg.



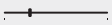

**LOWER TEMPERATURE LIMIT**

**10.0°C**



## • Función HILO PILOTO (\*No disponible en España. Sólo bajo demanda.)

La función HILO PILOTO permite controlar su calefacción únicamente a través del programador por hilo piloto.

Active o desactive la función de control por HILO PILOTO. Con las teclas  y , seleccione ON para activar y OFF para desactivar. Pulse  para confirmar y salir. En la pantalla principal aparecerá .

**PILOT WIRE**

ON

OFF



**19.0°C**

10:50

1 2 3 4 5 6 7

## 5.10. FUNCIONALIDADES DE AHORRO ENERGÉTICO

### • Tecnología FUZZY LOGIC ENERGY CONTROL

Este producto incluye la tecnología FUZZY LOGIC ENERGY CONTROL, la cual gestiona el consumo de energía del producto de la manera más eficiente. FUZZY LOGIC ENERGY CONTROL es una tecnología que basa su funcionamiento en la generación de miles de micro cortes en el consumo energético de la resistencia para mantener la temperatura del consigna estable con un consumo mínimo.

Cuando el símbolo **FZL** reemplaza al símbolo , entonces la tecnología FUZZY LOGIC ENERGY CONTROL está en funcionamiento.

### • Indicador de ajuste temperatura/eficiencia

El indicador de ajuste de la temperatura se muestra en la pantalla del producto para indicar qué nivel de temperatura se ha ajustado en la programación, lo que afecta directamente a su consumo. Un indicador verde significa que la temperatura está fijada entre 7 - 18,5°C. Un indicador rojo está entre 25°C - 30°C. Este indicador aparece automáticamente y no puede ser alterado manualmente.

## 6. MANTENIMIENTO Y LIMPIEZA

El producto no necesita ningún tipo de mantenimiento. Recomendamos la limpieza del producto (parte trasera, inferior del producto, aletas superiores, etc.). No utilice sustancias abrasivas sobre el producto, límpielo con un paño húmedo y jabón pH neutro y la pantalla con un paño seco. Antes de efectuar cualquier operación de limpieza, asegúrese de que el radiador está apagado y a temperatura ambiente.

## 7. NORMATIVA EUROPEA 2012/19/UE



En base a la normativa europea 2012/19/UE de Residuos de Aparatos Eléctricos y Electrónicos (RAEE), dichos aparatos no pueden ser arrojados en los contenedores municipales habituales; tienen que ser recogidos selectivamente para optimizar la recuperación y reciclado de los componentes y materiales que los constituyen, y reducir el impacto en la salud humana y el medio ambiente. El símbolo del cubo de basura tachado sobre barra horizontal se marca sobre todos los productos Roointe para recordar al consumidor la obligación de separarlos para la recogida selectiva. El consumidor debe contactar con la autoridad local o con el vendedor para informarse en relación a la correcta eliminación de su aparato.

## 8. GARANTÍA

### 1. Acuerdo

1.1. En este apartado, se describen las condiciones de garantía de las que dispone el comprador al haber adquirido un nuevo producto de la marca Rointe. Estas condiciones reúnen todos los derechos que tiene el comprador de acuerdo con la legislación nacional vigente, así como la garantía y los derechos adicionales que ofrece la marca.

1.2. Cualquier incidencia que detecte en su producto Rointe, puede ser atendida por el vendedor del producto o de una forma más ágil a través del propio fabricante. Rointe, pone a su disposición el **TELÉFONO DE ASISTENCIA TÉCNICA 900 103 061 (968 864 363) o email a sat@rointe.com**, donde le indicaremos los pasos a seguir para solucionar dicha incidencia. **Necesitará la referencia de producto (ubicada en la etiqueta metálica de características), número de serie, fecha de compra y la naturaleza del fallo al contactar con nosotros. Además, deberá disponer de una copia del comprobante de compra del producto.**

1.3. ROINTE garantiza que no hay defectos materiales de diseño o fabricación en el momento de la compra original. ROINTE garantiza el cuerpo de aluminio durante 120 meses (10 años) y los componentes eléctricos y electrónicos durante 36 meses (3 años) solo para este producto, desde la fecha de compra, o entrega si esta fue posterior, siempre que no haya sido modificado, y de acuerdo con lo dispuesto en las estipulaciones siguientes.

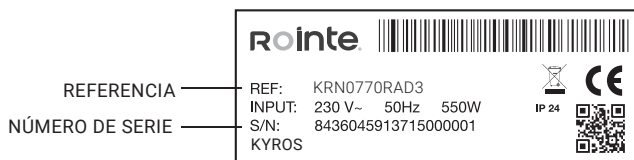

### 2. Condiciones

2.1. Si durante el periodo de garantía, el producto, con un uso normal y el debido mantenimiento, no funciona correctamente y se encuentra algún defecto de diseño, material o fabricación, se reparará o sustituirá a elección del cliente, de acuerdo con lo previsto en la ley, y con los términos y condiciones siguientes:

2.1.1. La garantía sólo es aplicable si la garantía original es emitida por el vendedor y cuando dicha garantía haya sido registrada en ROINTE correctamente, incluyendo la referencia del producto, el número de serie (marcado en la etiqueta metálica del producto), la fecha de compra y el comprobante de compra. La garantía del producto puede registrarse en nuestro sitio web en [www.rointe.com](http://www.rointe.com) o puede enviarse por correo electrónico a [sat@rointe.com](mailto:sat@rointe.com) en un plazo de 90 días a partir de la instalación. ROINTE se reserva el derecho de rechazar la

garantía cuando esta información se haya eliminado o modificado después de la compra del producto original.

2.1.2. La garantía solo es aplicable si el producto ha sido instalado por una persona competente de acuerdo con este manual de instalación y todas las normativas vigentes en el momento de la instalación.

2.1.3. La garantía solo es aplicable a aquellos casos que se refieren a defectos de material, diseño y fabricación, y en ningún caso cubre los daños del producto por los siguientes motivos:

- i) Daños causados por negligencia y/o mal uso del producto, es decir, utilizado para otros fines que no se consideren su uso normal o por no respetar las instrucciones de uso, mantenimiento y limpieza dadas por ROINTE, así como la instalación o el uso incorrecto o inadecuado del producto que pueda no cumplir con las normas técnicas de seguridad vigentes.
- ii) La corrosión de cualquier parte del producto causada por la exposición directa al agua salada. Cuando el producto se instale a menos de 200 m de la costa, el periodo de garantía para los daños causados por la corrosión se reducirá en un 50%.
- iii) Cualquier modificación no autorizada o reparaciones del producto llevadas a cabo por terceros o personas no autorizadas, o la apertura del producto por terceros o personas no autorizadas.
- iv) Cualquier accidente que se considere fuera del control de ROINTE, como (pero no limitado a): rayos, incendios, inundaciones, desastres naturales, desórdenes públicos, fenómenos atmosféricos o geológicos, y todos aquellos de análoga naturaleza.
- v) Los fallos que resulten de una instalación incorrecta. En caso de duda, póngase en contacto con ROINTE.

2.2. Cualquier reparación o sustitución realizada como parte de este servicio de garantía no permite periodos de ampliación o nuevos periodos de garantía, es decir, su garantía no se ampliará en caso de que se realice una reparación o sustitución de este producto, sino que esta quedará en suspenso hasta que el producto sea devuelto, reparado o entregado uno nuevo.

2.3. Cualquier reparación o sustitución cubierta por esta garantía debe ser una pieza equivalente desde el punto de vista funcional. Las piezas defectuosas o las piezas retiradas o sustituidas pasarán a ser propiedad de ROINTE y deberán ser devueltas como tales.

2.4. El producto debe instalarse de forma que permita el acceso de los técnicos de ROINTE o de personas autorizadas en caso de que necesiten acceder al producto para su reparación o mantenimiento. El usuario/cliente es responsable de los medios organizativos necesarios para permitir el acceso a los productos por ROINTE para su reparación o sustitución.

2.5. El departamento de Soporte Técnico de ROINTE le asesorará si necesita adquirir alguna pieza no cubierta por esta garantía o fuera de ella.

2.6. Esta garantía no será válida si el producto ha sido manipulado, modificado y/o reparado de cualquier manera y/o por personas no autorizadas. Esta garantía tampoco será válida si el

producto no está correctamente instalado.

2.7. Esta garantía no es transferible y no incluye reclamaciones por daños por cal o heladas.

2.8. Esta garantía no afecta a los derechos legales del comprador estipulados en la legislación nacional vigente, ni afecta a los derechos contraídos con el distribuidor o instalador que pudieran surgir en cumplimiento del contrato de compraventa.

2.9. ROINTE, sus oficinas, empleados, distribuidores e instaladores no se harán responsables de ningún daño accidental que se produzca por la infracción de cualquier norma implícita en este producto, así como por su uso inadecuado o incorrecto.

2.10. Compruebe las condiciones del EULA (suministradas con el producto) para obtener información sobre el acuerdo legal que acepta al instalar un producto de ROINTE. Para ayuda sobre el producto o la garantía, por favor contacte con ROINTE por teléfono 900 103 061 (o 968 864 363) o envíe un correo electrónico a [sat@rointe.com](mailto:sat@rointe.com).



## 9. CÓMO REGISTRAR LA GARANTÍA DE SU PRODUCTO

**IMPORTANTE:** Es importante que registre su producto ROINTE como parte de nuestro servicio de garantía, en caso de que quiera hacer una reclamación.

Puede registrar su producto ROINTE de las siguientes maneras:

### **WEB**

1. Acceda a [www.rointe.com/compania/registra-tu-garantia/](http://www.rointe.com/compania/registra-tu-garantia/).
2. Ingrese a su cuenta existente o cree una nueva cuenta si es necesario.
3. Haga clic en "Mis productos".
4. Introduzca la referencia de su producto (alfanumérica y en mayúsculas).
5. Introduzca su número de serie (26 dígitos situados en la etiqueta metálica de su producto que comienzan con 84).
6. Suba su prueba de compra, como la factura en formato PDF, JPEG o PNG. Esto no es obligatorio, pero al hacerlo se asegura que su período de garantía es exacto.
7. Haga clic en "Registro".
8. Enhorabuena! Su producto ya está registrado.

### **EMAIL**

1. Envíe un correo electrónico a [sat@rointe.com](mailto:sat@rointe.com) con la siguiente información:
  - Nombre del cliente
  - Dirección y código postal
  - Número de teléfono y dirección de correo electrónico
  - Referencia del producto
  - Número de serie
  - La fecha de compra del producto y el comprobante de compra (como se describe en la sección del SITIO WEB más arriba).
2. Nuestro equipo de soporte técnico confirmará el registro del producto y solicitará cualquier información adicional necesaria por correo electrónico.

### **POSTAL**

1. Envíe la información que figura en la sección EMAIL a:
  - INDUSTRIAS ROYAL TERMIC, S.L. - Rointe, C/E Parcela 43, 30140, Santomera (ESPAÑA)
2. Por favor, asegúrese de obtener una prueba de envío.

## SÍMBOLOS



**PERIGO.** Este símbolo indica um risco médio-alto que, se não for evitado, pode resultar em ferimentos graves ou morte.



**NÃO COBERTAR.** As roupas ou toalhas não devem ser secas no radiador, nem devem ser deixados panos, revistas, latas de spray, substâncias voláteis ou objectos semelhantes num raio de 250 mm do radiador.



**SUPERFÍCIE QUENTE.** Este símbolo indica que as suas superfícies estão quentes durante e imediatamente após a sua utilização. Não devem ser tocados: perigo de queimaduras.



**OBSERVAR AS INSTRUÇÕES DO MANUAL.** Por favor, leia atentamente o manual antes de instalar e utilizar o produto. Guarde-o para utilização posterior. Ler todas as instruções e avisos de segurança. O não seguimento pode resultar em choque eléctrico, incêndio, bem como ferimentos graves.

**INDICE**

1. Advertências gerais .....	60
2. Informação técnica .....	62
3. Instalação .....	64
4. Teclado e monitor .....	67
5. Funcionalidade e programação .....	68
5.1. Ligar e desligar .....	68
5.2. Ajustar dia e hora .....	68
5.3. Selecção de temperatura .....	69
5.4. Bloqueio do painel de controlo .....	69
5.5. Menu principal.....	70
5.6. Menu principal: Submenu de configuração.....	70
5.7. Menu principal: Submenu de energia .....	71
5.8. Menu principal: Submenu equilibrio.....	73
5.9. Menu principal: Submenu programação.....	73
5.9.1. Funções manual/automático.....	74
5.9.2. Programação .....	74
5.9.3. Modo usuario.....	78
5.10. Funcionalidades de poupança energética.....	80
6. Manutenção e limpeza .....	80
7. Regulamento Europeu (RAEE) 2012/19/UE .....	80
8. Garantia .....	81
9. Como registar a garantia do seu produto .....	84
Diretiva ERP Regulamento da Comissão .....	85
Declaração de Conformidade da UE .....	86

## 1. ADVERTÊNCIAS GERAIS



### ADVERTÊNCIAS

Este produto pode ser utilizado por crianças com mais de 8 anos de idade e por pessoas com capacidades físicas, sensoriais ou mentais reduzidas, ou com falta de experiência e conhecimento, se lhes tiver sido dada supervisão ou instruções relativas à utilização do produto de uma forma segura e compreender os perigos envolvidos. As crianças não devem ligar, regular, limpar, brincar com, ou prestar assistência a este produto. As crianças com menos de 3 anos de idade devem ser mantidas afastadas do produto, a menos que sejam supervisionadas.



Não manusear o dispositivo em espaços fechados se estiverem presentes pessoas que não possam sair da sala independentemente e que não estejam sob supervisão constante.

**NÃO COBERTAR.** Para evitar o sobreaquecimento, não cobrir o radiador.

Não colocar latas de spray, substâncias voláteis ou objectos semelhantes num raio de 250mm do produto. Não utilizar insecticidas, tintas, produtos químicos sobre ou perto do produto.



Partes deste produto podem atingir altas temperaturas e causar queimaduras. Não tocar nas partes externas do emissor quando em funcionamento. Não instalar perto de cortinas ou outros materiais inflamáveis. Deve ser tomado especial cuidado quando crianças e pessoas vulneráveis estiverem presentes.

Ao utilizar aparelhos eléctricos, devem ser tomadas precauções para reduzir o risco de incêndio, choque eléctrico e ferimentos em pessoas. Nunca inserir dedos, partes do corpo ou objectos no interior do produto.

Certifique-se de que a potência indicada nas informações técnicas do produto corresponde à potência de saída que tem na sua tomada.

Qualquer reparação ou manutenção que exija a abertura do produto deve ser efectuada por ROINTE ou por pessoal autorizado, na qual deve ser notificado se for observada uma fuga. Só devem ser utilizadas peças de substituição oficiais aprovadas pelo fabricante. É favor observar os regulamentos ao eliminar este produto e o seu fluido térmico.

Se o cabo de alimentação for danificado, deve ser substituído por ROINTE ou pelo seu pessoal autorizado para evitar qualquer dano.

Para evitar o risco de asfixia, não deixar os sacos e outros acessórios ao alcance de bebés e crianças.

O produto tem um grau de protecção IP24 e pode ser utilizado em casas de banho, mas não nas proximidades de banheiras, duchas, ligações de água, pias, piscinas ou outros corpos de água. O produto nunca deve ser instalado onde os interruptores ou o painel de controlo estejam ao alcance das pessoas na água. Nunca operar o produto com as mãos molhadas. Não colocar quaisquer recipientes com água (copos, vasos, etc.) sobre ou perto do produto.



## IMPORTANTE

- Desligar o produto da fonte de alimentação e certificar-se de que o produto está à temperatura ambiente antes de qualquer limpeza ou manutenção. Não utilizar quaisquer substâncias abrasivas no produto, tais como (mas não limitadas a) produtos químicos, panos rugosos, escovas de cerdas duras ou lã de arame/aço.
- Para desligar o produto da fonte de alimentação principal, retirar a ficha da tomada. Não puxar o cabo.
- ROINTE não pode ser responsabilizada por produtos com dimensões incorrectas, a menos que um inquérito técnico oficial ROINTE tenha sido seguido.
- Antes do primeiro arranque ou antes do início da estação de Inverno ou quando o transmissor não tiver sido utilizado durante vários dias, o dispositivo deve ser limpo (seguir os passos na secção “manutenção” deste manual).
- Não sentar ou apoiar no produto.
- Os contrastes de temperatura podem gerar “estalidos” ou ruídos no dispositivo. Isto não é uma falha do produto, mas deve-se à expansão/contracção dos materiais.
- Ao eliminar os emissores, devem ser observados os requisitos legais para o tratamento e reciclagem de resíduos. Ver REEE no ponto 7.

## 2. INFORMAÇÃO TÉCNICA

MODELOS	0330RAD3	0550RAD3	0770RAD3	0990RAD3	1210RAD3	1430RAD3	1600RAD3
Número de elementos	3	5	7	9	11	13	15
<b>DIMENSÕES, PESO E ACABAMENTOS</b>							
Largura (mm)	350	510	670	830	990	1.150	1.310
Altura (mm)	580	580	580	580	580	580	580
Profundidade (mm)	95	95	95	95	95	95	95
Profundidade instalado (mm)	118	118	118	118	118	118	118
Peso (kg)	7,7	12,2	16,4	20,1	24,1	27,8	32,1
Acabamentos	Branco RAL 9016						
<b>CARACTERÍSTICAS ELÉCTRICAS</b>							
Potência nominal (W)	330	550	770	990	1.210	1.430	1.600
Potência efectiva (W)	125	209	293	376	460	543	608
Voltagem (V)	230 ~V	230 ~V	230 ~V	230 ~V	230 ~V	230 ~V	230 ~V
Intensidade (A)	1,5	2,4	3,4	4,3	5,3	6,2	7,0
<b>RENDIMENTO DE SEGURANÇA E INSTALAÇÃO</b>							
Termóstato de segurança	✓	✓	✓	✓	✓	✓	✓
Grau de protecção	IP24	IP24	IP24	IP24	IP24	IP24C	IP24
Kit de instalação incluído	✓	✓	✓	✓	✓	✓	✓
<b>CÓDIGO EAN</b>	8436045917454	8436045917461	8436045917478	8436045917485	8436045917492	8436045917508	843605917515

## 3. INSTALAÇÃO

Recomendamos a utilização de um fornecedor Rointe de confiança. Encontre o mais próximo contactando para o número **+(351) 22 120 01 14** ou utilizando o localizador em **www.rointe.pt**.

**IMPORTANTE:** Antes da instalação, por favor localizar a etiqueta prateada no verso do produto e anotar a referência do produto e o número de série. Precisar desta informação para registar a sua garantia, ver secção 9 para registo de garantia.

**AVISO:** Não instalar o produto directamente numa tomada ou caixa de junção fixa. Não instalar o produto ou utilizá-lo ao ar livre. Não instalar directamente debaixo de uma prateleira. Este produto foi concebido para ser instalado numa parede interior utilizando o modelo ROINTE, kit de instalação e fixadores fornecidos. Não instalar o produto de forma que este entre em contacto com o cabo de alimentação.

O produto deve ser montado na parede na posição indicada na imagem anexa, utilizando os parênteses e fixações fornecidos.

Os nossos produtos transferem calor através da convecção natural do ar. Se o produto estiver coberto, isto perturbará o fluxo de ar e poderá causar sobreaquecimento. Deve ser posicionado de acordo com as distâncias mínimas mostradas na imagem.

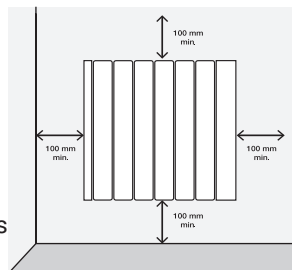

**AVISO:** O produto tem um grau de protecção IP 24 e pode ser utilizado em casas de banho, mas não nas proximidades de banheiras, chuveiros, ligações de água, lavabos ou outros corpos de água. Só pode ser instalado na zona 3. O produto nunca deve ser instalado onde ele ou os interruptores/painéis de controlo estejam ao alcance das pessoas na água.

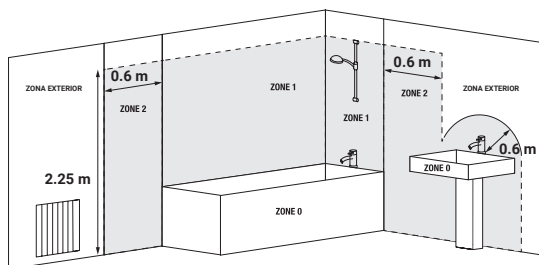



Dentro da embalagem do produto encontrará um kit de instalação. Será necessário um berbequim, um macete de borracha, um nível e um lápis para completar a instalação.

**ADVERTÊNCIA.** O peso de alguns dos produtos pode ser pesado. A instalação pode requerer a intervenção de duas pessoas.

**IMPORTANTE:** Por favor, siga cuidadosamente estas instruções.

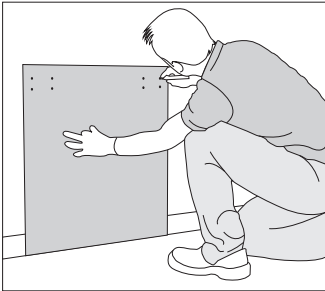

1. Retirar a embalagem e verificar se o kit de instalação contém suportes, parafusos, tampões e modelo de cartão.
2. Seleccionar a localização apropriada na parede. Colocar o modelo na parede e marcar os furos para os suportes e parafusos. Observar os requisitos de distância mínima na página anterior.

**Utilizar o chão como base para o modelo, não o rodapé.**

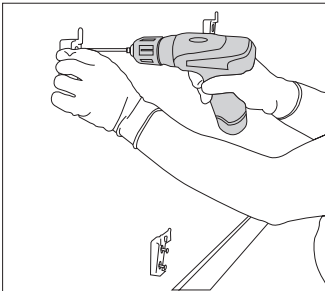

3. Retirar o modelo e perfurar cuidadosamente os furos marcados.
4. Fixar os suportes superiores com as cavilhas e parafusos fornecidos. Em seguida, fixar o suporte inferior.

**NOTA:** Para o distinguir, o suporte inferior tem um desenho diferente dos parênteses superiores.

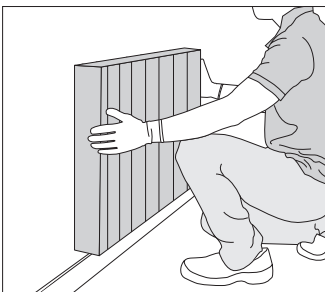
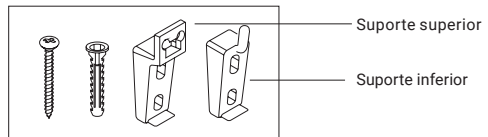

5. Deslizar o produto para cima e para baixo sobre suportes fixos.
6. Verificar a rectidão com um nível e ajustar os suportes em conformidade, se necessário.

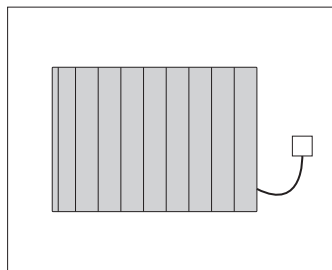

1. Ligar o seu produto à fonte de alimentação e ligue-o.
2. Consultar a secção 5 para instruções de funcionamento.

**IMPORTANTE:** Modelo de medição por modelo.

**KR\*0330RAD3**

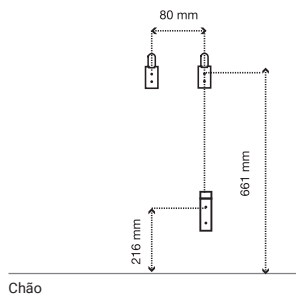

**KR\*0550RAD3**

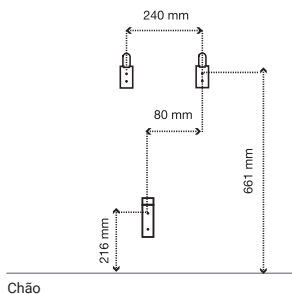

**KR\*0770RAD3**

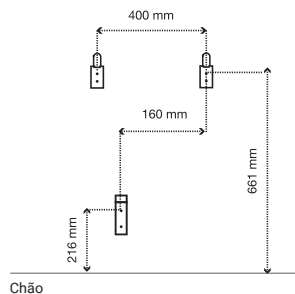

**KR\*0990RAD3**

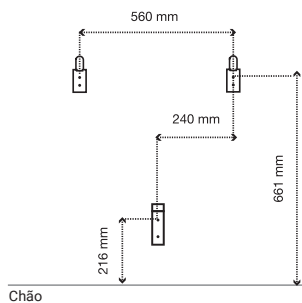

**KR\*1210RAD3**

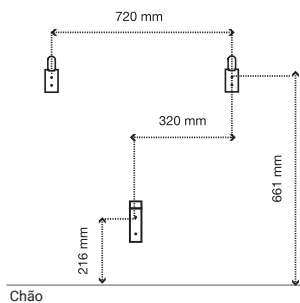

**KR\*1430RAD3 /  
KR\*1600RAD3**

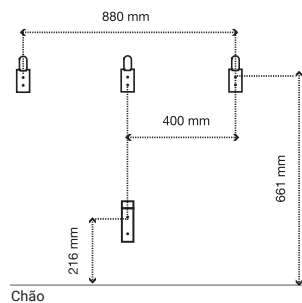



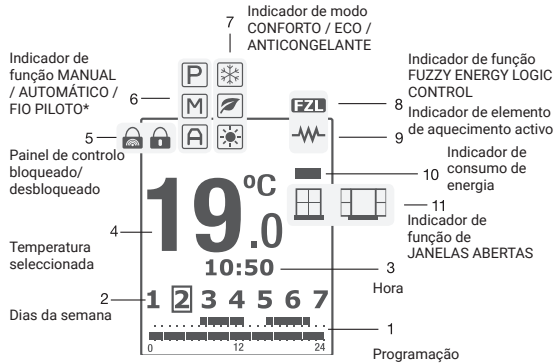
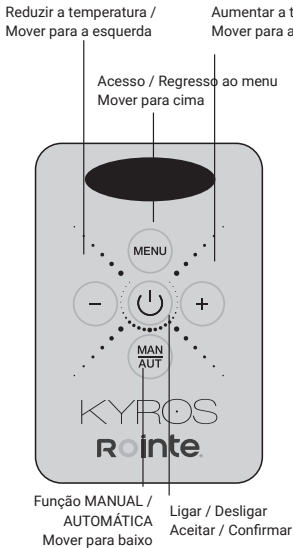

## 4. TECLADO E MONITOR







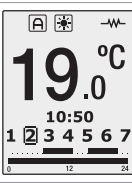





SÍMBOLO	DESCRIÇÃO	SÍMBOLO	DESCRIÇÃO
	Função JANELAS ABERTAS - detectado		Função AUTOMÁTICO - ativo
	Função JANELAS ABERTAS - ativo		Função MANUAL - ativo
	Indicador de consumo de energia - verde / amarelo / vermelho		Função FIO PILOTO - ativo <b>*Não disponível em Espanha ou Portugal. Somente por encomenda.</b>
	Elemento de aquecimento - ativo		Função AUTOMÁTICO - ativo no modo USUARIO
	Tecnológica FUZZY ENERGY LOGIC CONTROL - ativo		Função MANUAL - ativo no modo USUARIO
	Modo CONFORTO - ativo		Função FIO PILOTO - ativo no modo USUARIO <b>*Não disponível em Espanha ou Portugal. Somente por encomenda.*</b>
	Modo ECO - ativo		Bloqueio através do painel de controlo do producto
	Modo ANTICONGELANTE - ativo		Bloqueado através do comando à distância





## 5. FUNCIONALIDADE E PROGRAMAÇÃO

### 5.1. LIGAR E DESLIGAR (STAND BY)

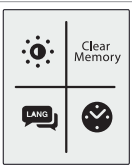
<p>Carregue sobre a tecla  e apaga ou liga o producto. Ao ligar o producto irá aparecer a seguinte imagem de boas-vindas no visor TFT.</p>	
<p>Passados 3 segundos, irá visualizar a temperatura principal no visor.</p>	
<p>Se está ligado, carregue de novo na tecla , e o producto passará ao modo 'STAND-BY'. Passados 5 segundos aparecerá o logo da Rointe e o visor apagar-se-á.</p>	



### 5.2. AJUSTAR DIA E HORA

<p>Ao carregar no botão , acede ao menu principal. Utilizando os botões  e  seleccione o submenu de configuração  ao pulsar  para aceder.</p>	
<p>No submenu de configuração utilize os botões  e  para seleccionar a opção relógio  e carregue em  para aceder.</p>	



Ao carregar uma vez o botão , ao carregar duas vezes acederá aos minutos e três vezes para os dias da semana. Enquanto piscam poderá ajustar cada valor ao carregar os botões  e  e se confirma com o botão  .  
\*Para sair do ajuste de dia e hora, espere 30 segundos ou carregue  e depois da seleção dos dias da semana.

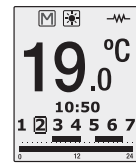

### 5.3. SELECÇÃO DA TEMPERATURA

As teclas de direção  ou  permitem alterar a temperatura de referência. Se a temperatura da habitação for inferior ao valor selecionado, o produto entra em operação, aparecendo o símbolo .





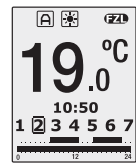



Uma vez ativada a tecnologia Fuzzy Logic Energy Control, é exibido o logotipo  no ecrã, no mesmo local, onde se encontrava o símbolo de resistência ativa .



### 5.4. BLOQUEIO DO PAINEL DE CONTROLO

É possível bloquear o produto a partir do próprio produto ou a partir dos comandos (não incluso).



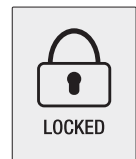

A partir do próprio produto e se carrega simultaneamente durante 3 segundos nos botões  e , ligar-se-á o ícone de bloqueio do teclado . Ao carregar em qualquer tecla irá aparecer-lhe no visor a imagem da direita. Para desbloquear, carregue outra vez nas teclas  e  durante 3 segundos: o ícone  desaparecerá no visor.







Quando bloqueia a partir do comando à distância, aparecerá no visor o ícone de bloqueio remoto de teclado . Ao carregar em qualquer tecla do produto, no visor apresentar-se-á a imagem da direita. O bloqueio remoto do teclado somente pode desbloquear-se com o comandos.







## 5.5. MENU PRINCIPAL



Para aceder ao menu principal do seu producto KYROS carregue no botão . Para mover os distintos submenus que aparecem utilize os botões  e . A opção seleccionada aparecerá ressaltada com uma moldura que pisca; se acederá ao menu seleccionado com a tecla .

Abaixo detalhamos os ícones que permitem aceder aos distintos menus:





				
Submenu de configuração	Submenu de energia	Função de equilíbrio	Submenu de programação	

## 5.6. MENU PRINCIPAL: SUBMENU DE CONFIGURAÇÃO

O submenu de configuração ajusta os quatro parâmetros técnicos do seu produto. Para aceder, seleccione o ícone  do menu principal e confirmaremos ao carregar no botão . Aparecerá no visor da direita e poderá mover-se pelas distintas opções do submenu utilizando os botões  e . Os seguintes ícones permitem-lhe aceder aos distintos submenus que se indicam abaixo:

	Clear Memory			
Iluminação de tela	Limpar memória	Idioma	Hora	

### • Ajuste a iluminação do visor

Esta função permite mudar o brilho do visor para os modos STAND-BY e ACTIVO (ON). Com os botões  e  e irá alternando entre as duas opções. Com os botões  e  pode aumentar ou reduzir o valor da iluminação. O cursor indica a intensidade da iluminação seleccionada dentro do rango. Uma vez terminado carrega  para confirmar e sair.

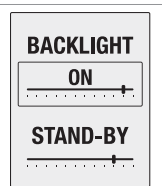

### • Limpar memória



Isto permite apagar qualquer informação guardada no seu producto ao pulsar  para confirmar.

Quando se selecciona esta função, o idioma por defeito, mudará para o de fabrico.



• Idioma

Para aceder a esta função, certifique-se de que o ícone está a piscar no submenu e prima para confirmar.

Esta função permite seleccionar o idioma preferido para comunicar com o produto. Com os botões  e  selecione o idioma e carregue  para confirmar o idioma sublinhado.







• Ajustar dia e hora

Esta função ajusta a hora, os minutos e o dia da semana a partir do próprio produto. Para ajustar a hora e o dia, consulte por favor o ponto 5.2.







5.7. MENU PRINCIPAL: SUBMENU DE ENERGIA

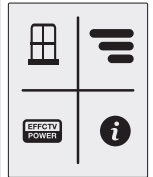

O submenu energia, dá acesso às funções relacionadas com a gestão energética do produto. Selecione mediante as teclas  e  o ícone  do menu principal. Carregue em  para aceder a este visor.

Os seguintes ícones permitem aceder aos distintos submenus:



			
Função JANELAS ABERTAS	Status de consumo de energia	Função de potência efetiva	Informação

## • Função JANELAS ABERTAS

Esta opção, permite activar ou desactivar a função Janelas Abertas. Com os botões  e , seleccione ON para ativar e OFF para desativar. Uma vez marcada a opção desejada carregue  para confirmar e sair.

Esta função é activada quando há uma queda de pelo menos 4°C na temperatura ambiente dentro de 30 minutos. Isto ocorre normalmente quando uma janela é deixada aberta, deixando escapar ar quente e desperdiçando energia. Se isto acontecer, o seu produto activará automaticamente o modo Anti-gelo durante 2 horas. Para desactivar esta função, pressionar o botão on/off.



## • Status de consumo de energia

Esta função mostra o status do consumo de alertar o usuário se o produto funciona corretamente ou há um problema que faz com que o produto tem um consumo excessivo. Quando a tecla é pressionada , aparece um dos seguintes telas de acordo com o estado de consumo do produto.



**Até 40%**  
da potência efectiva





**Entre 40% e 60%**  
da potência efectiva



**Mais de 60%**  
da potência efectiva

## • Função de potência efetiva



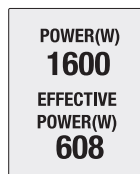

Para comprovar o estado da Potência Efectiva do seu produto, assegure-se que o ícone  pisca no submenu "Energia" e carregue no botão  para aceder. Esta opção mostra o visor o tempo de consumo real do produto e o tempo total durante o qual se encontra conectado à rede eléctrica. Passados uns segundos, sem ter que carregar em nenhum botão, o visor mostrará a potência nominal e a potência efectiva do mesmo.

\*A potência efectiva corresponde ao valor da potência média que realmente consome durante o funcionamento.









## • Informação



Esta opção mostra a versão de software, a data de lançamento e a potência nominal do produto. Poderá a esta ao seleccionar o ícone  do submenu energia e mediante os botões  e  e carregue no botão  para confirmar.

Para sair do ecrã de informação, prima .

SOFTWARE  
VERSION  
**V3.65**  
11/11/2021  
POWER 1600W

## 5.8. MENU PRINCIPAL: SUB-MENU EQUILIBRIO

O submenu equilíbrio faz com que o produto trabalhe em função MANUAL com uma temperatura constante de 19°C. Acede seleccionando a partir do menu principal o ícone de equilíbrio  utilizando as teclas  e . Confirme mediante a tecla . Depois de pulsar esta tecla, o produto voltará ao visor principal, com a temperatura estabelecida em 19°C e com o ícone função manual ligado.

M    
**19.0**  
10:50  
1 2 3 4 5 6 7

## 5.9. MENU PRINCIPAL: SUBMENU PROGRAMAÇÃO





Neste apartado explica-se os aspectos relacionados com o funcionamento do produto nas suas distintas funções e modos.

### O que é que são as funções MANUAL, AUTOMÁTICO e FIO PILOTO?

MANUAL	Esta função permite alternar entre os modos de trabalho CONFORTO, ECO e ANTICONGELANTE, modificando a temperatura como se indicou no ponto 5.3.
AUTOMÁTICO	Esta função activa a programação que tenha gravada no produto.
FIO PILOTO	Esta função permite controlar o produto a partir de uma central externa conectada pelo FIO PILOTO. *Não disponível em Espanha ou Portugal. Somente por encomenda.

### O que são os modos CONFORTO, ECO e ANTICONGELANTE?



 CONFORTO	 ECO	 ANTICONGELANTE
A partir dos 19°C aos 30°C	A partir dos 7,5°C aos 18,5°C	7°C

O submenu programação dá acesso às funções relacionadas com a programação do produto. Aceda selecionando o ícone  do menu principal. Utilize os botões  e  para mover-se entre as diferentes opções do submenu e selecione o programa que deseja ao pulsar . Os ícones que se indicam mais abaixo, permitem aceder aos distintos submenus que se indicam:

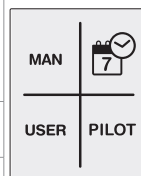

MAN/AUTO		USER	PILOT
Funções MANUAL / AUTOMÁTICO	Programação	Modo USUARIO	Modo FIO PILOTO <b>*Não disponível em Espanha ou Portugal. Somente por encomenda.*</b>



## 5.9.1. FUNÇÕES MANUAL/AUTOMÁTICO

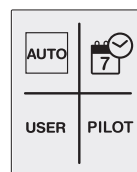
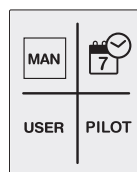



Para mudar o escolher entre as funções MANUAL ou AUTOMÁTICO, assegure-se que o ícone **MAN/AUTO** esté parpadeando y pulse el botón  para confirmar. Carregue no botão  para alternar entre as funções MANUAL e AUTOMÁTICO. A função AUTOMÁTICO activa a programação estabelecida no produto.

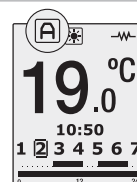
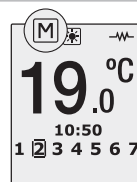









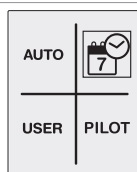











No visor principal aparecerá o símbolo  para a função AUTOMÁTICO e o símbolo  para a função MANUAL.

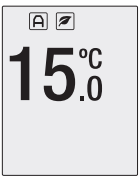

## 5.9.2. PROGRAMAÇÃO

Para começar a programação carregue sobre o ícone , utilizando os botões  e  para mover-se e confirme mediante a tecla .



<p>No visor aparecerão duas opções para selecionar:</p> <ul style="list-style-type: none"> <li>• PRÉ-PROGRAMAÇÃO: uma das quatro programações pré-estabelecidas.</li> <li>• START PROGRAMMING: para programar os modos CONFORTO e ECO.</li> </ul> <p>A opção irá piscar quando seleccionada. Use os botões  e  para cambiar e prima  para confirmar.</p>	
<ul style="list-style-type: none"> <li>• START PROGRAMMING para modo AUTOMÁTICO</li> </ul> <p>Para programar o modo Automático, veja os pontos anteriores e assegure-se que o START PROGRAMMING está selecionado. Pressione o botão  para confirmar e o visor iluminar-se-á.</p> <p>PASSO 1 – Selecione temperatura modo CONFORTO</p> <p> O modo CONFORTO será programado primeiro. Selecione temperatura modo CONFORTO entre 19°C e 30°C os botões  e . O ícone  e a temperatura piscarão. Pressione  para confirmar.</p>	
<p>Passo 2 – Selecione temperatura modo ECO</p> <p> Modo ECO será programado em seguida. Selecione a temperatura modo ECO entre 7,5°C e 18,5°C. O ícone  e a temperatura piscarão. Pressione  para confirmar.</p>	
<p>Passo 3 – Selecionar o dia</p> <p>Os dias da semana começarão a piscar no visor e mostrar-se-á como DIA 1, DIA 2, DIA 3, etc. Utilize os botões  e  para mover para frente e para atrás, segundo os dias apresentados. Pressione  para selecionar o dia ou os dias, os quais você deseja incluir no seu programa AUTOMÁTICO.</p> <p>Uma vez que seja selecionado o dia, deixará de piscar. Repita o processo para todos os dias que você deseja programar e uma vez que tenha todos os dias selecionados, pressione o botão  para passar a configurar a hora.</p>	

## PASSO 4 – Selecione as horas

Quando completar o passo 3, aparecerá no visor 0h (equivale à meia-noite). Utilize os botões **-** e **+** para selecionar a hora que você deseja mudar. Utilize o botão **⏻** para mudar (o modo CONFORTO, ECO ou nada), para a hora que você deseja modificar. O ícone correspondente aparecerá segundo cada modo.

Para finalizar a programação pressione **MENU** ou espere 30seg sem pressionar nenhum botão. Para mudar a programação volte ao passo 1 e proceda segundo a descrição anterior.

\*Se você deseja modificar uma programação diferente para distintos dias, deverá modificar cada dia separadamente; comece pelo menu principal para cada dia ou dias a modificar. Siga os passos 1 até 4 para programar diferentes dias, horas e temperaturas.

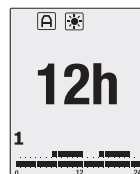

## • PRE-PROGRAMAÇÕES:

Para ESCOLHER uma PRÉ-PROGRAMAÇÃO para o seu produto:

Assegure-se que o START PROGRAMMING está selecionado. Carregue no botão **⏻** para confirmar e o visor mostrar-lhe-á os 4 programas a escolher: A1, A2, A3 e A4.

Utilizando os botões **-** e **+**, escolha o programa que você deseja activar e quando esteja a piscar, pressione o botão **⏻** para confirmar. Automaticamente o visor retrocederá ao visor principal e a sua opção pré-programada será exibida no visor para que seja confirmada.

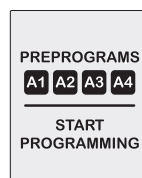

Para MODIFICAR uma PRÉ-PROGRAMAÇÃO no seu Radiador:

Você irá necessitar que o seu produto esteja em modo Automático e depois então poderá selecionar a pré-programação que deseja modificar; o seu produto deverá trabalhar ou ter já activada a pré-programação que deseja modificar.

Assegure-se que o START PROGRAMMING está selecionado. Carregue no botão **⏻** para confirmar e o painel de visualização mostrar-lhe-á o visor iluminado. Deverá seguir os passos 1 até ao 4, indicados anteriormente, para poder modificar a temperatura, o dia e a hora.

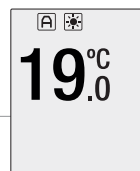
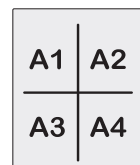

• Cronograma do programa pré-instalado:







PROGRAMA	A1		A2		A3	A4	
	Seg - Sex	Sáb - Dom	Seg - Sex	Sáb - Dom	Seg - Dom	Seg - Sex	Sáb - Dom
00:00							
01:00							
02:00							
03:00							
04:00							
05:00							
06:00	CONFORTO		CONFORTO		CONFORTO		
07:00	CONFORTO	CONFORTO	CONFORTO	CONFORTO	CONFORTO	CONFORTO	ECO
08:00	CONFORTO	CONFORTO	CONFORTO	CONFORTO	CONFORTO	CONFORTO	ECO
09:00	CONFORTO	CONFORTO	CONFORTO	CONFORTO	CONFORTO	CONFORTO	ECO
10:00	ECO	CONFORTO	ECO	CONFORTO	CONFORTO	CONFORTO	ECO
11:00	ECO	ECO	ECO	ECO	CONFORTO	CONFORTO	ECO
12:00	ECO	CONFORTO	CONFORTO	CONFORTO	CONFORTO	CONFORTO	ECO
13:00	ECO	CONFORTO	CONFORTO	CONFORTO	CONFORTO	CONFORTO	ECO
14:00	ECO	CONFORTO	CONFORTO	CONFORTO	CONFORTO	CONFORTO	ECO
15:00	CONFORTO	CONFORTO	ECO	CONFORTO	CONFORTO	CONFORTO	ECO
16:00	CONFORTO	ECO	ECO	ECO	CONFORTO	ECO	ECO
17:00	CONFORTO	ECO	CONFORTO	ECO	CONFORTO	ECO	ECO
18:00	CONFORTO	ECO	CONFORTO	ECO	CONFORTO	ECO	ECO
19:00	CONFORTO		CONFORTO	CONFORTO	CONFORTO	ECO	ECO
20:00	CONFORTO		CONFORTO	CONFORTO	CONFORTO	ECO	ECO
21:00	CONFORTO		CONFORTO	CONFORTO	CONFORTO	ECO	ECO
22:00	CONFORTO		CONFORTO	CONFORTO	CONFORTO	ECO	ECO
23:00	ECO				ECO		

CONFORTO
ECO
ANTI-CONGELANTE





## 5.9.3. MODO DE USUARIO

A selecção desta opção permite atribuir um limite superior e inferior à temperatura do setpoint.

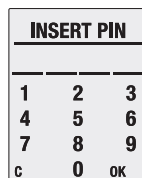





Para aceder ao modo USER, certifique-se de que o ícone **USER** está a piscar no submenu  para confirmar.



Será necessário um PIN de quatro dígitos para aceder ao menu. O PIN predefinido está definido para 0000. Para introduzir o PIN use os botões  e  e  e  para mover para a esquerda, direita, para cima e para baixo respectivamente e confirme premindo  depois de cada número que pretende alterar e está a piscar. Quando todos os 4 dígitos estiverem correctamente definidos, passe para OK e prima  para confirmar. Uma vez concluído correctamente este processo, serão mostradas as funções desejadas do submenu. Os seguintes ícones permitem aceder aos distintos menus que se detalham abaixo:



			
Activar/ desactivar modo de USUARIO	Alterar o código PIN	Limite máximo de temperatura	Limite mínimo de temperatura

### • Activar / Desactivar Modo USUARIO

Primeiro certifique-se de que o ícone  está a piscar e confirme com o botão . Usando as teclas  e , para cima e para baixo respectivamente, seleccionar ON para activar e OFF para desactivar. Uma vez destacada a opção desejada, prima  para confirmar. Utilizar o botão  para voltar ao menu principal, ou esperar 30 segundos sem premir nenhum botão.

Na parte superior do visor principal aparecerá o ícone  para função Automático, e  para função Manual.



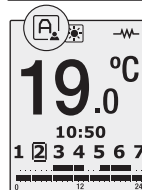
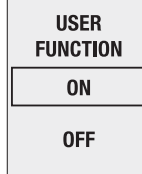

Caso nos encontremos em função de controlo por Fio Piloto, aparecerá no visor principal o ícone .

**\*Função FIO PILOTO não disponível em Espanha ou Portugal. Somente por encomenda.**



### • Alterar o código PIN

Assegure-se que está sobre o ícone  e que este pisca no menu, agora pressione  para confirmar.

Esta função permite mudar a password para aceder ao modo Usuário. Selecione os números do novo PIN utilizando os botões , ,  e . Quando termine o processo, aceite com ao pulsar OK e aparecerá no visor PIN CHANGED para confirmar a alteração.

\* Lembre-se do seu novo código PIN para o futuro e mantenha-o em um lugar seguro.

#### NEW PIN



1	2	3
4	5	6
7	8	9
CANCEL	0	OK



PIN  
CHANGED

### • Limite máximo de temperatura

Assegure-se que está sobre o ícone  e que este pisca no menu, agora pressione  para confirmar.





Esta função permite modificar a temperatura máxima de trabalho do produto. Com os botões  e  pode-se aumentar ou reduzir a temperatura entre os 19°C e 30°C. Quando seleccione o valor desejado, carregue em  para sair.

Para terminar carregue no botão  ou espere 30 segundos.

UPPER  
TEMPERATURE  
LIMIT  
22.0°C

### • Limite mínimo de temperatura





Assegure-se que está sobre o ícone  e que este pisca no menu, agora pressione  para confirmar.

Esta função permite modificar a temperatura mínima de trabalho do produto. Com os botões  e  pode-se aumentar e reduzir a temperatura entre os 7,5°C e 18,5°C. Quando seleccione o valor desejado, carregue  para sair. Para terminar carregue no botão  ou espere 30 sg.

LOWER  
TEMPERATURE  
LIMIT  
10.0°C

### • Função FIO PILOTO (\*Não disponível em Espanha ou Portugal. Somente por encomenda.\*)



A função de fio piloto permite-lhe controlar o seu aquecimento apenas através do controlador de fio piloto.

Activa ou desactiva o função de controlo por Fio Piloto. Com as teclas  e , seleccione ON para activar e OFF para desactivar. Carregue  para confirmar e sair. No visor principal aparecerá .

PILOT  
WIRE

ON



OFF

   
19.0°C  
10:50  
1 2 3 4 5 6 7

## 5.10. FUNCIONALIDADES DE POUPANÇA DE ENERGIA

### • Tecnologia FUZZY LOGIC ENERGY CONTROL

Este produto inclui a tecnologia FUZZY LOGIC ENERGY CONTROL, que gere o consumo de energia do produto da forma mais eficiente. FUZZY LOGIC ENERGY CONTROL é uma tecnologia que baseia o seu funcionamento na geração de milhares de micro cortes no consumo de energia do elemento de aquecimento para manter a temperatura de setpoint estável com um consumo mínimo.

Cuando o símbolo  substitui o símbolo , então a tecnologia FUZZY LOGIC ENERGY CONTROL está em funcionamento.

### • Indicador de ajuste temperatura/eficiência

O indicador de ajuste de temperatura é mostrado no visor do produto para indicar qual o nível de temperatura definido na programação, o que afecta directamente o seu consumo. Um indicador verde significa que a temperatura é definida entre 7 - 18,5°C. Um indicador vermelho está entre 25°C - 30°C. Este indicador aparece automaticamente e não pode ser alterado manualmente.

## 6. MANUTENÇÃO E LIMPEZA

O produto não requer qualquer manutenção. Recomendamos a limpeza do produto (parte de trás, de baixo, etc.). Não utilizar substâncias abrasivas no produto, limpá-lo com um pano húmido e sabão de pH neutro e a tela com um pano seco. Antes de efectuar qualquer operação de limpeza, certifique-se de que o produto está desligado e à temperatura ambiente.

## 7. REGULAMENTO EUROPEU 2012/19/UE

Com base no regulamento europeu 2012/19/UE sobre resíduos de equipamentos eléctricos e electrónicos (REEE), estes aparelhos não podem ser atirados para os contentores municipais habituais; devem ser recolhidos selectivamente para otimizar a recuperação e reciclagem dos componentes e materiais que os compõem, e para reduzir o impacto na saúde humana e no ambiente. O símbolo do caixote do lixo riscado numa barra horizontal é marcado em todos os produtos Rointe para lembrar ao consumidor a obrigação de os separar para recolha separada. O consumidor deve contactar a autoridade local ou o retalhista para obter informações sobre a correcta eliminação do seu aparelho.



## 8. GARANTIA

### 1. Acordo

1.1. Esta secção descreve as condições de garantia que o comprador tem quando compra um novo produto da marca Rointe. Estas condições incluem todos os direitos que o comprador tem em conformidade com a legislação nacional em vigor, bem como a garantia e os direitos adicionais oferecidos pela marca.

1.2. Qualquer incidente detectado no seu produto Rointe pode ser tratado pelo vendedor do produto ou de uma forma mais ágil através do próprio fabricante. Rointe, coloca à sua disposição o TELEFONE DE APOIO TÉCNICO +(351) 22 120 01 14 ou e-mail para sat@rointe.com, onde indicaremos os passos a seguir para resolver o incidente. Necessitará da referência do produto (localizada na etiqueta de características metálicas), número de série, data de compra e a natureza da falha quando nos contactar. Além disso, é necessário ter uma cópia da prova de compra do produto.

1.3. ROINTE garante que não existem defeitos materiais de concepção ou fabrico no momento da compra original. ROINTE garante o corpo de alumínio por 120 meses (10 anos) e os componentes eléctricos e electrónicos por 36 meses (3 anos) apenas para este produto, a partir da data de compra, ou entrega se mais tarde, desde que não tenha sido modificado, e de acordo com as disposições das seguintes estipulações.

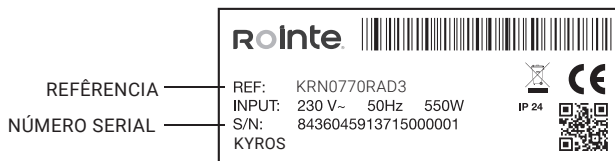

### 2. Condições

2.1. se, durante o período de garantia, o produto, sob utilização normal e manutenção adequada, não funcionar correctamente e for considerado defeituoso na concepção, material ou mão-de-obra, será reparado ou substituído por opção do cliente, de acordo com as disposições da lei, e sujeito aos seguintes termos e condições:

2.1.1. A garantia só é aplicável se a garantia original for emitida pelo vendedor e quando tal garantia tiver sido registada correctamente na ROINTE, incluindo a referência do produto, número de série (marcado no rótulo metálico do produto), data de compra e prova de compra. A garantia do produto pode ser registada no nosso website em [www.rointe.pt](http://www.rointe.pt) ou pode ser enviada por e-mail para [sat@rointe.com](mailto:sat@rointe.com) no prazo de 90 dias após a instalação. ROINTE reserva-se o direito de recusar a garantia quando esta informação tiver sido removida ou modificada após a compra do produto original.

2.1.2. A garantia só é aplicável se o produto tiver sido instalado por uma pessoa competente, de

acordo com este manual de instalação e todos os regulamentos em vigor no momento da instalação.

2.1.3. A garantia só é aplicável aos casos que se referem a defeitos de material, desenho e mão-de-obra, e em nenhum caso cobre danos ao produto pelas seguintes razões:

(i) Danos causados por negligência e/ou má utilização do produto, ou seja, utilizado para fins diferentes do seu uso normal ou por não respeitar as instruções de utilização, manutenção e limpeza dadas pela ROINTE, bem como instalação ou utilização incorrecta ou inadequada do produto que possa não estar em conformidade com as normas técnicas de segurança em vigor.

ii) Corrosão de qualquer parte do produto causada pela exposição directa a água salgada. Quando o produto for instalado a menos de 200 m da costa, o período de garantia para danos causados pela corrosão será reduzido em 50%.

iii) Quaisquer modificações ou reparações não autorizadas do produto efectuadas por terceiros ou pessoas não autorizadas, ou a abertura do produto por terceiros ou pessoas não autorizadas.

iv) Qualquer acidente considerado fora do controlo de ROINTE, tal como (mas não limitado a): raios, incêndios, inundações, catástrofes naturais, desordens públicas, fenómenos atmosféricos ou geológicos, e todos aqueles de natureza semelhante.

v) Falhas resultantes de instalação incorrecta. Em caso de dúvida, por favor contacte ROINTE.

2.2 Qualquer reparação ou substituição efectuada como parte deste serviço de garantia não permite períodos de extensão ou novos períodos de garantia, ou seja, a sua garantia não será prolongada no caso de uma reparação ou substituição deste produto, mas será suspensa até que o produto seja devolvido, reparado ou seja entregue um novo.

2.3. Qualquer reparação ou substituição coberta por esta garantia deve ser uma peça funcionalmente equivalente. As partes defeituosas ou partes removidas ou substituídas tornar-se-ão propriedade de ROINTE e devem ser devolvidas como tal.

2.4. O produto deve ser instalado de modo a permitir o acesso de técnicos ROINTE ou de pessoas autorizadas no caso de necessitarem de aceder ao produto para reparação ou manutenção. O utilizador/cliente é responsável pelos meios organizacionais necessários para permitir o acesso aos produtos por ROINTE para reparação ou substituição.

2.5. O departamento de suporte técnico de ROINTE irá assessorar caso necessite adquirir alguma peça que não está coberta pela garantia ou fora dela.

2.6. Esta garantia não será válida se o produto tiver sido adulterado, modificado e/ou reparado de qualquer forma e/ou por pessoas não autorizadas. Esta garantia também não será válida se o produto não estiver correctamente instalado.

2.7. Esta garantia não é transmissível e não inclui reclamações por danos causados por cal ou geada.

2.8. Esta garantia não afecta os direitos estatutários do comprador ao abrigo da legislação nacional aplicável, nem afecta quaisquer direitos contratados com o revendedor ou instalador

que possam surgir ao abrigo do contrato de venda.

2.9. ROINTE, os seus escritórios, funcionários, distribuidores e instaladores não serão responsáveis por quaisquer danos acidentais decorrentes da violação de qualquer regra implícita neste produto, bem como pela sua utilização imprópria ou incorrecta.

2.10. Verifique as condições EULA (fornecidas com o produto) para obter informações sobre o acordo legal que aceita ao instalar um produto ROINTE. Para assistência sobre produtos ou garantia, contactar ROINTE pelo telefone +(351) 22 120 01 14 ou e-mail [sat@rointe.com](mailto:sat@rointe.com).

## 9. COMO REGISTRAR A GARANTIA DO SEU PRODUTO

**IMPORTANTE:** É importante que registre o seu produto ROINTE como parte do nosso serviço de garantia, caso deseje fazer uma reclamação.

Pode registar o seu produto ROINTE das seguintes formas:

### **WEB**

1. Vá a [www.rointe.com/pt/registe-a-sua-garantia/](http://www.rointe.com/pt/registe-a-sua-garantia/).
2. Inicie sessão na sua conta existente ou crie uma nova conta se necessário.
3. Clique em “Os Meus Produtos”.
4. Introduza a referência do seu produto (alfanumérica e em letras maiúsculas).
5. Introduza o seu número de série (26 dígitos localizados na etiqueta metálica do seu produto começando por 84).
6. Carregue a sua prova de compra, tal como uma factura em formato PDF, JPEG ou PNG. Isto não é obrigatório, mas ao fazê-lo garante que o seu período de garantia é preciso.
7. Clique em “Registar”.
8. Parabéns! O seu produto está agora registado.

### **EMAIL**

1. Enviar um e-mail para [sat@rointe.com](mailto:sat@rointe.com) com as seguintes informações:
  - Nome do cliente
  - Endereço e código postal
  - Número de telefone e endereço de correio electrónico
  - Referência do produto
  - Número de série
  - A data de compra do produto e a prova de compra (como descrito acima na secção do WEBSITE).
2. A nossa equipa de apoio técnico confirmará o registo do produto e solicitará qualquer informação adicional requerida por correio electrónico.

### **POSTAL**

1. Por favor envie a informação na secção EMAIL para:
  - INDUSTRIAS ROYAL TERMIC, S.L. - Rointe C/E Parcela 43, 30140, Santomera (ESPAÑA)
2. Por favor, não se esqueça de obter uma prova de envio.

## ERP. REGLAMENTO DE LA COMISIÓN (EU) 2015/1188

ITEM	SYMBOL	UD.	0330RAD3	0550RAD3	0770RAD3	0990RAD3	1210RAD3	1430RAD3	1600RAD3
<b>HEATING POWER / POTENCIA CALORÍFICA / PODER DE AQUECIMENTO</b>									
Nominal heat output / Potencia calorífica nominal / Produção nominal de calor	P <sub>nom</sub>	kW	0,3	0,6	0,8	1,0	1,2	1,4	1,6
Minimum heating capacity (indicative) / Potencia calorífica mínima (indicativa) / Produção mínima de calor (indicativo)	P <sub>min</sub>	kW	N.A.*	N.A.*	N.A.*	N.A.*	N.A.*	N.A.*	N.A.*
Maximum continuous heat output / Potencia calorífica máxima continuada / Máxima saída de calor continuada	P <sub>max,c</sub>	kW	0,3	0,6	0,8	1,0	1,2	1,4	1,6
<b>AUXILIARY ELECTRICITY CONSUMPTION / CONSUMO AUXILIAR DE ELECTRICIDAD / CONSUMO DE ELECTRICIDADE AUXILIAR</b>									
Nominal heat output / Potencia calorífica nominal / Produção nominal de calor	e <sub>lMAX</sub>	kW	0,330	0,550	0,770	0,990	1,210	1,430	1,600
Minimum heating capacity (indicative) / Potencia calorífica mínima (indicativa) / Produção mínima de calor (indicativo)	e <sub>lMIN</sub>	kW	0,330	0,550	0,770	0,990	1,210	1,430	1,600
In stand-by / En modo de espera / Em modo de espera	e <sub>lSB</sub>	kW	0,0006	0,0006	0,0006	0,0006	0,0006	0,0006	0,0006
<b>TYPE OF HEAT OUTPUT/INDOOR TEMPERATURE CONTROL / TIPO DE CONTROL DE POTENCIA CALORÍFICA / DE TEMPERATURA INTERIOR / TIPO DE SAÍDA DE CALOR/ CONTROLO DE TEMPERATURA DO AR</b>									
Electronic indoor temperature control and weekly timer / Control electrónico de temperatura interior y temporizador semanal / Controlo electrónico da temperatura interior e temporizador semanal			SI	SI	SI	SI	SI	SI	SI
<b>OTHER CONTROL OPTIONS (SEVERAL CAN BE SELECTED) / OTRAS OPCIONES DE CONTROL (PUEDEN SELECCIONARSE VARIAS) / OUTRAS OPÇÕES DE CONTROLO (VÁRIAS PODEM SER SELECIONADAS)</b>									
Indoor temperature control with open window detection / Control de temperatura interior con detección de ventanas abiertas / Controlo da temperatura interior com deteção de janela aberta			SI	SI	SI	SI	SI	SI	SI
With adaptive start-up control / Con control de puesta en marcha adaptable / Com controlo adaptativo de arranque			SI	SI	SI	SI	SI	SI	SI
With operating time limitation / Con limitación de tiempo de funcionamiento / Com limitação de tempo de funcionamento			SI	SI	SI	SI	SI	SI	SI
<b>SEASONAL ENERGY EFFICIENCY PERFORMANCE / RENDIMIENTO DE EFICIENCIA ENERGÉTICA ESTACIONAL / DESEMPENHO DE EFICIÊNCIA ENERGÉTICA SAZONAL</b>	<b>η<sub>s</sub></b>		38%	38%	38%	38%	38%	38%	38%

**DECLARATION OF CONFORMITY / DECLARACIÓN DE CONFORMIDAD /  
DECLARAÇÃO DE CONFORMIDADE**

**The company / la compañía / a empresa, ROINTE,**

Pl. Vicente Antolinós - C/E, parcela 43, 30140, Santomera (Murcia) España



**Declares under his responsibility / declara / declara:**

**Product / producto / produto:** Rointe KYROS

**Models / modelos / modelos:** KR\*0330RAD3, KR\*0550RAD3, KR\*0770RAD3, KR\*0990RAD3, KR\*1210RAD3, KR\*1430RAD3, KR\*1600RAD3

**General specifications / especificaciones generales / especificações gerais:** 230VAC, 50Hz, IP24, CLASE I

**To which this declaration relates is in conformity with the provisions of the following relevant Standard(s)/Specification(s)/Directive(s) / A la que se refiere esta declaración es conforme a las disposiciones de las siguientes Norma(s) / Especificación(es) / Directiva(s) pertinente(s) / A que esta declaração se refere está em conformidade com as seguintes disposições Norma(s)/Especificação(ões)/Directiva(s) relevante(s):**

<b>ErP Directive 2009/35/EU</b>	UE 2015/1188
<b>LVD Directive 2014/35/EU</b>	EN 60335-1:2012. Annexes A11:2014; A13:2017 EN 60335-2-30:2010. Annexes A11:2012
<b>EMC Directive 2014/30/EU</b>	EN 55014-1:2017 / EN 55014-2:2015 EN 62233:2008 + AC:2008
<b>RoHS Directive 2011/65/EU</b>	EN 62321-1:2013 / EN 50581:2012

The company declares that the above equipment has been designed to comply with the relevant sections of the above specifications. The equipment complies with all applicable essential requirements of the Directives.

La empresa declara que los equipos arriba mencionados han sido diseñados para cumplir con las secciones pertinentes de las especificaciones nombradas anteriormente. Los equipos cumplen con todos los requisitos esenciales aplicables de las Directivas.

A empresa declara que o equipamento acima referido foi concebido para cumprir com as secções pertinentes das especificações acima referidas. O equipamento cumpre com todos os requisitos essenciais aplicáveis das directivas.

NOTES / NOTAS

**Rointe España & Portugal**

Pl. Vicente Antolinos - C/ E, p. 43,  
30140, Murcia  
T. (ES) 900 103 061  
T. (PT) 221 200 114

**Rointe United Kingdom**

Hampton Business Park, Club Way,  
Peterborough PE7 8JA  
T. 0203 321 5928

**Rointe Ireland**

20 Harcourt Street, #247,  
Dublin 2, D02 H364  
T. +44 (0)203 321 5929 / 01 553 0523

**Rointe Nederland**

3197 LG Botlek, RT  
T. 010 742 00 46

Copyright © Rointe Heating 2022.

All rights reserved. As part of our continuous improvement policy, we reserve the right to alter or modify any product or specifications without prior notice. This also applies to products that have already been ordered, provided that such alterations can be made without subsequent changes to the already agreed specifications. We cannot accept responsibility for any errors in catalogues or other printed materials.

Todos los derechos reservados. Como parte de nuestra política de mejora continua, nos reservamos el derecho de alterar o modificar cualquier producto o especificaciones sin previo aviso. Esto también se aplica a los productos que ya se han pedido, siempre que dichas alteraciones puedan realizarse sin cambios posteriores en las especificaciones ya acordadas. No podemos aceptar la responsabilidad de ningún error en los catálogos u otros materiales impresos.

Todos os direitos reservados. Como parte da nossa política de melhoria contínua, reservamos o direito de alterar ou modificar quaisquer produtos ou especificações sem aviso prévio. Isto também se aplica aos produtos que já foram encomendados, desde que tais alterações possam ser feitas sem alterações subsequentes às especificações já acordadas. Não podemos aceitar responsabilidade por quaisquer erros em catálogos ou outros materiais impressos.

Allere rechten voorbehouden. In het kader van ons beleid van voortdurende verbetering behouden wij ons het recht voor om producten of specificaties zonder voorafgaande kennisgeving te wijzigen of aan te passen. Dit geldt ook voor reeds bestelde producten, mits dergelijke wijzigingen kunnen worden aangebracht zonder dat de reeds overeengekomen specificaties naderhand worden gewijzigd. Wij kunnen geen aansprakelijkheid aanvaarden voor eventuele fouten in catalogi of ander drukwerk.

MKRML22V1 - MPPAMAN420