

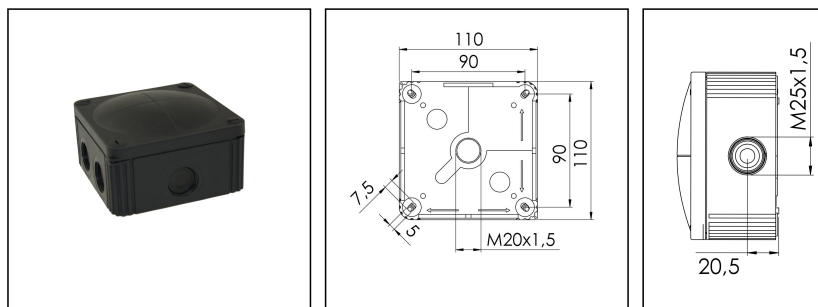

COMBI 607/5/2xKRM25/20 BK

Junction box, polypropylene



Products may differ in size, colour and appearance to those shown. If you require further information or customisation, please contact us directly.



Material	Polypropylene
Material sealing gasket	TPE
Temp. range min	-30 °C
Temp. range max	100 °C
Temperatures during install.	-5 °C - 60 °C
Protection class	IP66 / IP67
Glow wire test	750 °C
Voltage	690 V
Rated current / A (Terminal)	41 A
Rated cross section	5 x 6mm ²
Terminals/poles	6 mm ²
Fixing	4 internal openings
Ø cable diameter min	5,2 mm
Ø cable diameter max	17 mm
External dimensions LxWxH	110 x 110 x 66 mm
Using for cable gland	
Product Color	RAL 9005
WISKA-Order no.	10061779
Type	COMBI 607/5/2xKRM25/20 BK
Packing unit	3
ETIM-Classification	EC002600

Remarks:

IP66: using the membrane entry

Ø cable: 5,2 - 17 mm

Your Contact:

WISKA UK Ltd.

Unit 7, Hurling Way · St. Columb Major Business Park · TR9 6SX, St. Columb Major, Cornwall · Great Britain

☎ +44-12-08816062 · 📠 +44-12-08816708

info@wiska.co.uk · www.wiska.co.uk

IP67: using the threaded entry together with ESKV cable gland

Ø cable: 9,0 - 17 mm

Mounting:

- 4 internal openings outside of the sealing area

Equipment:

- 7 elastic, self-sealing puncture-membranes for cable entry on the side and 3 on the bottom

- 7 integrated M25 thread for mounting without lock nut

- 4 captive cover screws

- terminal block 5-pole, 6mm²

- 2 reduction adaptors KRM 25/20

Recommended accessories

MP-L Mounting plate large COMBI / WHK	10105775
External mounting - COMBI	10108836

Spare parts

SP-HKT 607 Terminal block	22000407
---------------------------	----------

17.03.2022

Your Contact:

WISKA UK Ltd.

Unit 7, Hurling Way · St. Columb Major Business Park · TR9 6SX, St. Columb Major, Cornwall · Great Britain

☎ +44-12-08816062 · 📠 +44-12-08816708

info@wiska.co.uk · www.wiska.co.uk

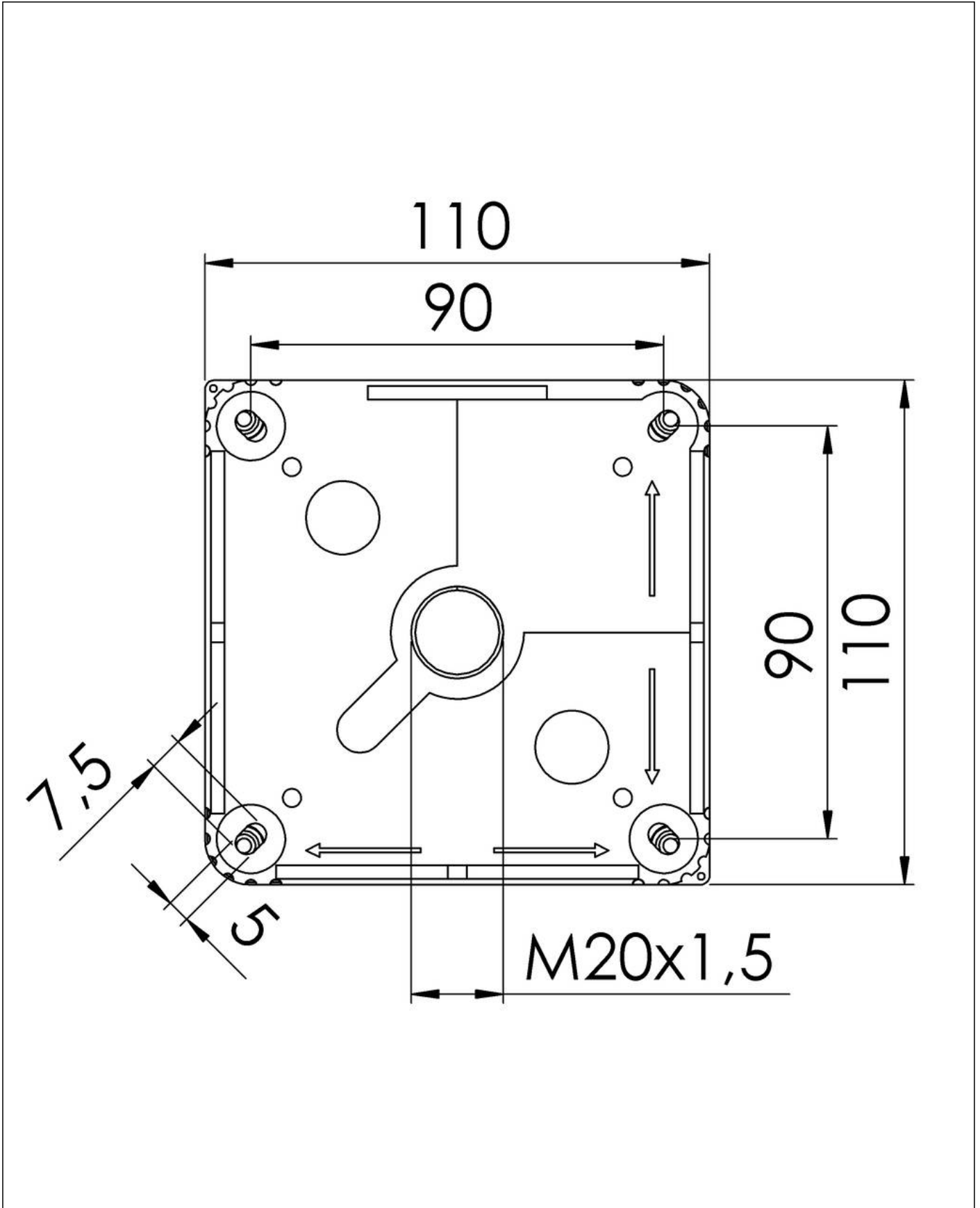

Your Contact:

WISKA UK Ltd.

Unit 7, Hurling Way · St. Columb Major Business Park · TR9 6SX, St. Columb Major, Cornwall · Great Britain

☎ +44-12-08816062 · 📠 +44-12-08816708

info@wiska.co.uk · www.wiska.co.uk



Your Contact:

WISKA UK Ltd.

Unit 7, Hurling Way · St. Columb Major Business Park · TR9 6SX, St. Columb Major, Cornwall · Great Britain

☎ +44-12-08816062 · 📠 +44-12-08816708

info@wiska.co.uk · www.wiska.co.uk